

# Aspect Medical Systems

## A-2000™ XP PLATFORM BISPECTRAL INDEX™ (BIS™) MONITORING SYSTEM



## SERVICE INFORMATION MANUAL

Rx Only

© Copyright, 2009, Aspect Medical Systems. All rights reserved. Copying or other reproduction of this document is prohibited without prior written consent of Aspect Medical Systems.

 Aspect Medical Systems, Inc.  
One Upland Road  
Norwood, MA  
U.S.A.  
(Tel) 617-559-7000  
(Tel) 888-BIS INDE(X) (U.S. only)  
(Fax) 617-559-7400  
bis\_info@aspectms.com  
www.aspectmedical.com

 Aspect Medical Systems International B.V.  
Rijnzathe 7d2  
3454 PV De Meern  
The Netherlands  
Tel: +31.30.662.9140  
Fax: +31.30.662.9150  
amsint@aspectms.com



075-0014 1.04



# TABLE OF CONTENTS

<b>1</b>	<b><u>SAFETY PRECAUTIONS</u></b>	<b><u>1-1</u></b>
1.1	WARNINGS	1-1
1.2	CAUTIONS	1-3
1.3	KEY TO SYMBOLS	1-5
<b>2</b>	<b><u>A-2000 SYSTEM OVERVIEW</u></b>	<b><u>2-1</u></b>
2.1	INTRODUCING THE A-2000 BIS MONITORING SYSTEM	2-1
2.1.1	PRINCIPAL COMPONENTS	2-1
2.1.2	HOW THE A-2000 WORKS	2-2
2.2	INSTRUMENT IDENTIFICATION	2-2
2.2.1	A-2000 MONITOR	2-2
2.2.2	A-2000 DIGITAL SIGNAL CONVERTER	2-2
2.2.3	SOFTWARE REVISION NUMBERS	2-2
2.3	PROPRIETARY INFORMATION AND DEVICES	2-2
<b>3</b>	<b><u>PRINCIPLES OF OPERATION</u></b>	<b><u>3-1</u></b>
3.1	HOW THE A-2000 MONITORING SYSTEM WORKS	3-1
3.2	SYSTEM ARCHITECTURE	3-1
3.2.1	THE DIGITAL SIGNAL CONVERTER (DSC)	3-4
3.2.2	THE A-2000 MONITOR	3-6
3.2.3	A-2000 PRINTER	3-7
3.3	SYSTEM FEATURES	3-7
3.3.1	SYSTEM SELF CHECKS	3-7
3.3.2	DATA MEMORY	3-8
3.3.3	SAVED SETTINGS	3-8
3.3.4	BATTERY OPERATION	3-8
3.3.5	DATA TRANSFER AND SOFTWARE UPDATES	3-8
3.3.6	PRINTED REPORTS	3-9
<b>4</b>	<b><u>PREPARATION FOR USE AND INSTALLATION</u></b>	<b><u>4-1</u></b>
4.1	ENVIRONMENT	4-1
4.1.1	SHIPPING AND STORAGE ENVIRONMENT	4-1
4.1.2	OPERATING ENVIRONMENT	4-1
4.1.3	POWER REQUIREMENTS AND SYSTEM GROUNDING	4-2
4.1.4	SITE PREPARATION: MOUNTING THE MONITOR	4-2
4.2	INSTRUMENT CONNECTIONS	4-3
4.2.1	DIGITAL SIGNAL CONVERTER CONNECTIONS	4-4
4.2.2	POWER CORD CONNECTIONS	4-4
4.2.3	PRINTER CONNECTOR	4-4

<b>4.3</b>	<b>INSTALLATION AND VERIFICATION PROCEDURE</b>	<b>4-5</b>
<b>5</b>	<b><u>PREVENTIVE MAINTENANCE, CARE AND CLEANING</u></b>	<b><u>5-1</u></b>
<b>5.1</b>	<b>CARE AND CLEANING</b>	<b>5-1</b>
5.1.1	CLEANING THE MONITOR AND DIGITAL SIGNAL CONVERTER	5-1
5.1.2	DISINFECTING THE MONITOR AND DIGITAL SIGNAL CONVERTER	5-1
5.1.3	CLEANING THE MONITOR DISPLAY	5-1
<b>5.2</b>	<b>PREVENTIVE MAINTENANCE</b>	<b>5-2</b>
5.2.1	CHECKING THE BATTERY	5-2
5.2.2	CHECKING LEAKAGE CURRENT	5-2
5.2.3	A-2000 MONITOR SYSTEM CHECKOUT PROCEDURE	5-3
5.2.4	DSC CHECKOUT PROCEDURE	5-4
5.2.5	PATIENT INTERFACE CABLE (PIC) CHECKOUT PROCEDURE	5-4
5.2.6	PHYSICAL INTEGRITY INSPECTION	5-5
<b>6</b>	<b><u>DIAGNOSTICS AND TROUBLESHOOTING</u></b>	<b><u>6-1</u></b>
<b>6.1</b>	<b>GENERAL TROUBLESHOOTING</b>	<b>6-1</b>
<b>6.2</b>	<b>A-2000 BIS MONITOR SYSTEM TROUBLESHOOTING PROCEDURE</b>	<b>6-2</b>
6.2.1	MONITOR TROUBLESHOOTING PROCEDURE	6-2
6.2.2	DSC TROUBLESHOOTING PROCEDURE	6-4
6.2.3	PIC AND SENSOR TROUBLESHOOTING PROCEDURE	6-5
6.2.4	DSC CABLE PROBLEM ISOLATION	6-6
<b>6.3</b>	<b>STATUS MESSAGES AND OPERATOR ACTIONS</b>	<b>6-7</b>
<b>7</b>	<b><u>SERVICING THE A-2000 SYSTEM</u></b>	<b><u>7-1</u></b>
<b>7.1</b>	<b>REPLACING MAJOR COMPONENTS</b>	<b>7-1</b>
7.1.1	TO REPLACE THE PIC:	7-1
7.1.2	TO REPLACE THE DSC:	7-2
7.1.3	TO REPLACE THE MONITOR:	7-2
<b>7.2</b>	<b>FUSE REMOVAL AND INSTALLATION</b>	<b>7-2</b>
<b>7.3</b>	<b>WHAT TO DO WITH A COMPONENT THAT REQUIRES SERVICE</b>	<b>7-3</b>
<b>7.4</b>	<b>REPACKAGING FOR SHIPPING AND STORAGE</b>	<b>7-3</b>
<b>7.5</b>	<b>DISASSEMBLING AND REASSEMBLING THE DSC</b>	<b>7-4</b>
7.5.1	REQUIRED TOOLS AND SUPPLIES	7-4
7.5.2	THE DSC CASE	7-5
7.5.3	THE DSC CABLES (MONITOR AND PIGTAIL)	7-9
7.5.4	DSC CHECKOUT AND SAFETY TESTS	7-10
<b>8</b>	<b><u>A-2000 SPECIFICATIONS</u></b>	<b><u>8-1</u></b>
<b>8.1</b>	<b>INTRODUCTION:</b>	<b>8-1</b>
<b>8.2</b>	<b>WARRANTY</b>	<b>8-4</b>
<b>9</b>	<b><u>APPENDIX I</u></b>	<b><u>9-1</u></b>

9.1	SPARES AND ACCESSORIES LIST .....	9-1
9.2	SENSOR SIMULATOR: P/N: 186-0137 FOR USE WITH DSC-XP: .....	9-2
9.3	TEST SENSOR.....	9-3
9.4	SAFETY TESTER CONNECTION WITH PIC.....	9-5
9.5	PLACEMENT OF PIC SECURING STRAP ON BIS MONITORING SYSTEM .....	9-6
<b>10</b>	<b><u>APPENDIX II .....</u></b>	<b><u>10-1</u></b>
10.1	A-2000 SIGNAL FLOW DIAGRAM .....	10-1
10.2	A-2000 BLOCK DIAGRAM .....	10-2
10.3	DSC WIRING DIAGRAM; DSC CONNECTOR (WIRE SIDE).....	10-3
10.4	WIRING DIAGRAM; MONITOR CABLE .....	10-4
10.5	WIRING DIAGRAM; PIGTAIL CABLE .....	10-5

## TABLE OF FIGURES

<i>Figure 2-1 The A-2000 BIS Monitoring System .....</i>	<i>2-3</i>
<i>Figure 2-2 Rear View of Monitor .....</i>	<i>2-4</i>
<i>Figure 3-1 The A-2000 System Block Diagram.....</i>	<i>3-2</i>
<i>Figure 3-2 The A-2000 Signal Flow Diagram .....</i>	<i>3-3</i>
<i>Figure 4-1 Pole Clamp.....</i>	<i>4-3</i>
<i>Figure 7-1 Placement of PIC Securing Strap on BIS Monitoring System .....</i>	<i>7-1</i>
<i>Figure 7-2 Remove the ground shield securing screw.....</i>	<i>7-6</i>
<i>Figure 7-3 Remove shield by sliding along pigtail cable. ....</i>	<i>7-6</i>
<i>Figure 7-4 Carefully separate the two printed circuit boards.....</i>	<i>7-7</i>
<i>Figure 7-5 For a new gasket, cable passages need to be carefully cut .....</i>	<i>7-8</i>
<i>Figure 7-6 Verify that the strain relief is fully secured in its recess.....</i>	<i>7-9</i>
<i>Figure 9-1 BIS Sensor .....</i>	<i>9-3</i>
<i>Figure 9-2 Connecting electrodes #2 and #4. ....</i>	<i>9-4</i>
<i>Figure 9-3 Connecting electrode #3 with #4, and #1 with #2. ....</i>	<i>9-4</i>
<i>Figure 9-4 Safety Tester Contact Points .....</i>	<i>9-5</i>

## ABOUT THIS MANUAL

This manual contains information necessary for the customer to install, maintain, service, identify and prepare for use the Aspect Medical System BIS™ Monitoring System. Also included are directions to diagnose, troubleshoot, and repair the system. A spare parts and accessories list and system specifications are included.

This manual is intended to be used in combination with the A-2000™ Operating Manual.

The A-2000 BIS Monitoring System is designed and manufactured using state-of-the-art components and manufacturing processes. Field repair or customer repairs are therefore limited by design to replacement of major component assemblies such as the Patient Interface Cable (PIC), Digital Signal Converter (DSC), or the A-2000 Monitor itself.

This manual, in conjunction with the A-2000 Operating Manual, contains the maintenance and diagnostic troubleshooting information necessary for customer qualified technical personnel to test and replace those parts of the equipment that are replaceable by the customer. Aspect does not authorize nor provide information to service or repair the internal components of the A-2000 Monitor.

**Section I** discusses important safety precautions. Before attempting to set up or service the A-2000, please familiarize yourself with the safety information provided in this section.

**Section II** provides a functional overview of the A-2000, its principal components, and instrument identification.

**Section III** describes the A-2000 monitor hardware and how it operates.

**Section IV** provides preparation for use and installation instructions, including environmental considerations, instrument connections and system setup and check out.

**Section V** describes normal maintenance, care and cleaning procedures.

**Section VI** describes the A-2000 diagnostic tools and provides tables to aid in troubleshooting the system.

**Section VII** describes the removal and replacement procedure for system components and how to return a component for service. It also explains how to disassemble and reassemble the DSC to replace cables.

**Note:**

This manual was not designed for repairing the A-2000 BIS system to the level of its electronic circuit boards. The manual is intended solely for the troubleshooting and replacement of its major components or DSC cables.

**Section VIII** contains the A-2000 specifications and warranty.

**Appendix I** provides instructions for use for the Sensor Simulator and describes how to make a test sensor. It also contains a list of spare parts and accessories.

**Appendix II** provides system diagrams.





**SECTION I****1 SAFETY PRECAUTIONS****INTRODUCTION****Caution:**

Carefully read the A-2000 BIS Monitoring System Operating Manual entirely before using the monitor in a clinical setting.

**WARNINGS, CAUTIONS, AND NOTES**

The terms warning, caution, and note have specific meanings in this manual.

- A WARNING advises against certain actions or situations that could result in personal injury or death.
- A CAUTION advises against actions or situations that could damage equipment, produce inaccurate data, or invalidate a procedure, although personal injury is unlikely.
- A NOTE provides useful information regarding a function or procedure.

**KEY TO SYMBOLS**

A key to the symbols used on the A-2000 appears at the end of this section.

**1.1 WARNINGS**

**GROUND WIRE LEAKAGE CURRENT MUST BE CHECKED BY A QUALIFIED BIOMEDICAL ENGINEERING TECHNICIAN WHENEVER INSTRUMENT CASE IS OPENED.**

**EXPLOSION HAZARD: DO NOT USE THE A-2000 IN A FLAMMABLE ATMOSPHERE OR WHERE CONCENTRATIONS OF FLAMMABLE ANESTHETICS MAY OCCUR.**

**ELECTRICAL SHOCK HAZARD: DO NOT REMOVE MONITOR COVERS DURING OPERATION OR WHILE POWER IS CONNECTED TO MONITOR.**

**ELECTRICAL SHOCK HAZARD: THE MANUFACTURER'S INSPECTION OF THIS APPARATUS VERIFIED THAT THE GROUND LEAKAGE CURRENT AND THE PATIENT SAFETY CURRENT WERE LESS THAN THE SPECIFIED LIMITS ESTABLISHED BY THE APPLICABLE SAFETY STANDARDS. AS A MATTER OF SAFE PRACTICE, THE INSTITUTION SHOULD CONDUCT PERIODIC TESTS TO VERIFY THESE CURRENTS.**

**SHOCK HAZARD: DO NOT ATTEMPT TO DISCONNECT THE POWER CORD WITH WET HANDS. MAKE CERTAIN THAT YOUR HANDS ARE CLEAN AND DRY BEFORE TOUCHING THE POWER CORD.**

**U.S.A. REQUIREMENT: FOR PROPER GROUNDING, THE POWER RECEPTACLE MUST BE A THREE-WIRE GROUNDED OUTLET. A HOSPITAL GRADE OUTLET IS REQUIRED. NEVER ADAPT THE THREE-PRONG PLUG FROM THE MONITOR TO FIT A TWO-SLOT OUTLET. IF THE OUTLET HAS ONLY TWO SLOTS, MAKE SURE THAT IT IS REPLACED WITH A THREE-SLOT GROUNDED OUTLET BEFORE ATTEMPTING TO OPERATE THE MONITOR.**

IF THE INTEGRITY OF THE EXTERNAL PROTECTIVE EARTH GROUND IS IN DOUBT, THE A-2000 SHALL BE OPERATED FROM ITS INTERNAL BATTERY POWER SOURCE ONLY.

FOR A-2000s USED OUTSIDE OF NORTH AMERICA: A HARMONIZED LINE CORD WITH CONDUCTORS HAVING A CROSS SECTIONAL AREA GREATER THAN 0.75 mm<sup>2</sup> MUST BE USED.

THE CONDUCTIVE PARTS OF ELECTRODES OR SENSOR AND CONNECTORS, INCLUDING THE NEUTRAL ELECTRODE, SHOULD NOT CONTACT OTHER CONDUCTIVE PARTS, INCLUDING EARTH.

ANY PROCEDURES THAT REQUIRE THE REMOVAL OF THE DSC'S COVER AND INTERNAL PARTS SHOULD BE PERFORMED BY A QUALIFIED BIOMEDICAL ENGINEERING TECHNICIAN. POWER OFF THE UNIT BY DISCONNECTING FROM THE MONITOR.

TO REDUCE THE HAZARD OF BURNS IN THE HIGH-FREQUENCY SURGICAL NEUTRAL ELECTRODE CONNECTION, THE SENSOR OR ELECTRODES SHOULD NOT BE LOCATED BETWEEN THE SURGICAL SITE AND THE ELECTRO-SURGICAL UNIT RETURN ELECTRODE.

TO REDUCE THE HAZARD OF BURNS DURING USE OF BRAIN-STIMULATING DEVICES (e.g., TRANSCRANIAL ELECTRICAL MOTOR EVOKED POTENTIAL), PLACE STIMULATING ELECTRODES AS FAR AS POSSIBLE FROM THE BIS SENSOR AND MAKE CERTAIN THAT SENSOR IS PLACED ACCORDING TO PACKAGE INSTRUCTIONS.

THE SENSOR MUST NOT BE LOCATED BETWEEN DEFIBRILLATOR PADS WHEN A DEFIBRILLATOR IS USED ON A PATIENT CONNECTED TO THE A-2000.

TO MINIMIZE THE RISK OF PATIENT STRANGULATION, THE PATIENT INTERFACE CABLE (PIC) MUST BE CAREFULLY PLACED AND SECURED.

WHENEVER AN EVENT SUCH AS SPILLAGE OF BLOOD OR SOLUTIONS OCCURS, RE-TEST GROUND LEAKAGE CURRENT BEFORE FURTHER USE.

BE SURE THE MONITOR IS MOUNTED SECURELY IN PLACE TO AVOID PERSONAL INJURY.

MONITOR IS NOT DESIGNED FOR USE IN MRI ENVIRONMENT.

UNIVERSAL PRECAUTIONS SHALL BE OBSERVED TO PREVENT CONTACT WITH BLOOD OR OTHER POTENTIALLY INFECTIOUS MATERIALS. PLACE CONTAMINATED MATERIALS IN REGULATED WASTE CONTAINER.

DO NOT MIX DISINFECTING SOLUTIONS (e.g., BLEACH AND AMMONIA), AS HAZARDOUS GASES MAY RESULT.

WHEN CONNECTING EXTERNAL EQUIPMENT (e.g., DATA CAPTURE COMPUTER), THE SYSTEM LEAKAGE CURRENT MUST BE CHECKED AND MUST BE LESS THAN THE IEC601-1-1 LIMIT.

**THE USE OF ACCESSORY EQUIPMENT NOT COMPLYING WITH THE EQUIVALENT SAFETY REQUIREMENTS OF THIS EQUIPMENT MAY LEAD TO A REDUCED LEVEL OF SAFETY OF THE RESULTING SYSTEM. CONSIDERATION RELATING TO THE CHOICE SHALL INCLUDE:**

- **USE OF THE ACCESSORY IN THE PATIENT VICINITY**
- **EVIDENCE THAT THE SAFETY CERTIFICATION OF THE ACCESSORY HAS BEEN PERFORMED IN ACCORDANCE TO THE APPROPRIATE IEC 601-1 AND/OR IEC 601-1-1 HARMONIZED NATIONAL STANDARD.**

**REPLACE FUSES ONLY WITH ONE OF THE FOLLOWING PARTS:**

**Aspect P/N 430-0006, 1.25 Amps, 250V, 5x20mm**

**Littelfuse 217 Series, 1.25 Amps, 250V, 5x20mm**

**Wickmann 193 Series, 1.25 Amps, 250V, 5x20mm**

**ALWAYS REPLACE BOTH FUSES TOGETHER, EVEN IF ONLY ONE HAS FAILED.**

## **1.2 CAUTIONS**

**Caution: U.S. Federal law restricts this device to sale by or on the order of a physician.**

**Read the entire A-2000 Operating Manual carefully before using the monitor in a clinical setting.**

**All repairs to the A-2000 Monitoring System should be made only by a qualified Biomedical Engineering Technician or other authorized personnel.**

**Do not autoclave the Digital Signal Converter or Monitor. Autoclaving will seriously damage both components.**

**Do not block fan output. Keep at least three 3 inches of unobstructed space between rear of instrument and wall and other instruments. Do not allow other instruments to block airflow. Do not block ventilation inlet holes on the underside of monitor.**

**Do not open Digital Signal Converter. The seal to prevent liquids from entering the Digital Signal Converter may be damaged if opened. Service or repairs must be performed only by qualified biomedical technicians.**

**Mixing of system configurations will increase sensor and hardware inventory requirements and may create user and support issues.**

**Using accessories other than those specified may result in increased electromagnetic emissions or decreased electromagnetic immunity of the BIS Monitoring System.**

**Each BIS sensor type has its own placement method. Be sure to carefully follow the appropriate package directions.**

**The A-2000 has been designed to operate with a disposable BIS Sensor. The sensor is a silver/silver chloride electrode array that utilizes Aspect's patented Zipprep™ technology and uses a proprietary connector. Use of other electrodes is not recommended.**

**Considerations when using Electro Convulsive Therapy (ECT) equipment during BIS™ monitoring: Place ECT electrodes as far as possible from the BIS sensor to minimize the effect of interference. Certain ECT equipment may interfere with the proper function of the BIS Monitoring System. Check for compatibility of equipment during patient setup.**

Continuous impedance checking may need to be disabled if the 1 nanoampere 128 Hz impedance check signal interferes with other equipment (e.g., evoked potential monitors).

Check the battery periodically, by operating an A-2000 that has been disconnected from the wall socket and that has been charging the battery for at least 4 hours. After long periods of storage (e.g., more than 1 month) it may be necessary to cycle (charge, then discharge) the battery a few times to get full charge capacity. If the A-2000 fails to operate reliably from the battery for 20 minutes, battery replacement is required.

The A-2000 contains an internal Nickel-Metal-Hydride battery. The battery must be removed by a qualified service technician and disposed of or recycled in accordance with the national laws of the country. Contact Aspect Medical Systems, Inc. or the local distributor for servicing of battery.

Avoid liquid ingress to the PIC. Contact of fluids with the PIC sensor connectors can interfere with PIC performance.

The A-2000 Monitor should not be used adjacent to or stacked with other equipment. If adjacent or stacked use is necessary, the A-2000 monitor should be observed to verify normal operation in the configuration in which it will be used.

The A-2000 system complies with the electromagnetic compatibility requirements of EN60601-1-2. Operation of this device may affect or be affected by other equipment in the vicinity due to electromagnetic interference (EMI). If this occurs:

- Increase separation between devices
- Re-orient device cabling
- Plug devices into separate outlet circuit branches

Consult Aspect Medical Systems Technical Support for assistance.

All work involving opening the instrument case must be performed in a static-safe environment to prevent damage to electronic components and assemblies. This environment includes the operator, work area and tools, and any other test or storage items that might touch the DSC assemblies.

Use only the parts and tools specified. Use of any others may damage the instrument.































Handle PCBs only by board edges to avoid contamination (moisture, skin oils, etc.) on PCB and component surfaces!





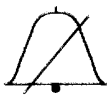

When connecting or disconnecting Digital Signal Converter, take care not to touch the exposed contacts of either connector. Damage due to electrostatic discharge may result.

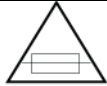
*A-2000 is a trademark of Aspect Medical Systems, Inc.*

*Bispectral Index, BIS, the BIS logo, and Zipprep are trademarks of Aspect Medical Systems, Inc. and are registered in the U.S.A., E.U. and other countries.*

## 1.3 KEY TO SYMBOLS

	Caution: Consult Accompanying Documents		Dangerous Voltage
J1 	Attention, J1 RS-232 Serial Port, Consult Accompanying Documents	J2 	Attention, J2 Printer Port, Consult Accompanying Documents
	Caution: Hot Surface		Storage Temperature Limits
	Type BF Equipment		Type BF Equipment Defibrillator-proof
	Alternating Current (A/C)		Direct Current (D/C)
	Battery Location		Reset Button
	Monitor Power ON		Monitor Power OFF or Standby Mode
	Do not Reuse		Use by YYYY-MM-DD or YYYY-MM
	Latex-free product		PVC-free product
	Manufacturer		Date of Manufacture
	Authorized Representative in the European Community		Catalog Number
	Batch Code		Serial Number
	Conformité Européenne (CE) Marking of Conformity to European Medical Device Directive. CE <sub>xxxx</sub> represents the Notified Body number		Classified by Underwriters Laboratories Inc.® with respect to electric shock, fire and mechanical hazards only, in accordance with UL 60601-1 and IEC60601-2-26
	Recognized under the Component Recognition Program of Underwriters Laboratories Inc.		Packaging Labeling: Fragile, Do Not Get Wet, and This Side Up
	Audible Alarm Silenced		Operating on Battery
	Alternating Current		Fuse, Replace only with same Type and Rating

	Equipotential		Protective Earth (ground)
	Recyclable		Crossed out wheellie bin indicates separate treatment from general waste at end of life *
	Product marked with a number contains certain toxic or hazardous substances or elements, and can be used safely during its Environment-Friendly Use Period (EFUP). The product should be recycled. The Environment-Friendly Use Period is valid only when the product is operated under the conditions defined in the product manual. **		Product marked with the "e" does not contain any toxic or hazardous substances or elements, and is green and environmental. The product can be recycled. **

\*Contact Aspect Medical Systems International B.V. for a Return Materials Authorization (RMA) number. According to the WEEE Directive 2002/96/EC, all waste electrical and electronic equipment (EEE) should be disposed of and collected separately and treated according to the best available and environmentally friendly techniques.

EEE contains hazardous substances to the (human) environment but also EEE is a valuable resource of new raw materials. Therefore it is important to collect WEEE separately from other waste.

*Aspect Medical products are subject to the Directive and we therefore urge you to dispose of the equipment separately and make sure that it is treated at an electronics recycler. Please contact your municipality or the nearest collection site and dispose of waste equipment there and make sure the discarded equipment does not end-up in the 'normal' household waste.*

\*\* Refer to [www.aspectmedical.com](http://www.aspectmedical.com) for Material Declaration Data Sheets.

## SECTION II

## 2 A-2000 SYSTEM OVERVIEW

## 2.1 INTRODUCING THE A-2000 BIS MONITORING SYSTEM

Aspect Medical Systems A-2000 BIS Monitoring System is intended to monitor the state of the brain by data acquisition of EEG signals in the intensive care unit, operating room, and for clinical research. The BIS, a processed EEG variable, may be used as an aid in monitoring the effects of certain anesthetic agents.

The A-2000 processes raw EEG signals to produce a single number, called the Bispectral Index™, or BIS, which correlates to the patient's level of hypnosis. It operates from an AC power source of 100V to 240V, 50/60Hz, and provides a minimum 20 minutes of automatic back-up battery power. The monitor is menu-driven with fixed keys for choosing the options available.

## 2.1.1 Principal Components

The system is composed of a monitor and a digital signal converter, with a patient interface cable (PIC), and BIS Sensor.

## 2.1.1.1 Monitor

The monitor contains the operator control panel, an electro-luminescent display screen, and connectors for the digital signal converter and printer.

## Front Panel Controls:

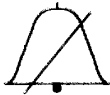

The [SILENCE] key toggles audible alarms on and off.



The left [←] and right [→] arrow keys are used to enter Review mode and to scroll data backward and forward in time. In the BIS Log, they show the previous [←] or next [→] screen of data .

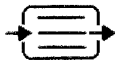

The [MENU/EXIT] key is used to enter and exit the Setup Menu. In Review mode it will return the user to the main screen. It is also used to halt certain procedures, such as the sensor check, and to answer "no" to a question.



The up [↑] and down [↓] arrows are used to move from one menu selection to another. They are also used to increment and decrement values. In the BIS Log, they are used to zoom time out or in (increase or decrease reporting intervals).



The [SELECT] key is used to move between options within a menu selection, to confirm an entry, and to answer "yes" to a question.

### **2.1.1.2 Digital Signal Converter (DSC)**

The Digital Signal Converter is about the size of a computer mouse. It contains the EEG amplifiers and analog filters. The DSC digitizes EEG waveforms for transmission to, and processing by, the monitor. The DSC's long flexible Monitor Interface Cable connects to the front of the monitor, and the shorter "DSC pigtail" cable connects to the Patient Interface Cable (PIC). The attachment clip on the DSC is used to secure it in a convenient location near the patient's head. The patient connection is accomplished by attaching the Aspect BIS Sensor to the PIC.

### **2.1.2 How The A-2000 Works**

A detailed description of how the A-2000 works is contained within Section V of the A-2000 Operating Manual and will not be discussed in this Service Manual. Please refer to the A-2000 Operating Manual (070-0015) for additional information.

## **2.2 INSTRUMENT IDENTIFICATION**

### **2.2.1 A-2000 Monitor**

Monitor identification information is permanently marked on the rear panel. This information includes instrument model and serial numbers, power ratings, cautions, and the Aspect Medical Systems shipping address.

### **2.2.2 A-2000 Digital Signal Converter**

The A-2000 Digital Signal Converter identification information is permanently marked on the rear panel of the Digital Signal Converter. This information includes instrument model and serial numbers and cautions.

### **2.2.3 Software Revision Numbers**

Software revision numbers are displayed in the Diagnostic Menu.

## **2.3 PROPRIETARY INFORMATION AND DEVICES**

Information and descriptions contained in this guide are the property of Aspect Medical Systems and may not be copied, reproduced or distributed without prior written permission. Portions of the A-2000 design are proprietary and are the subject of patents and patents pending.



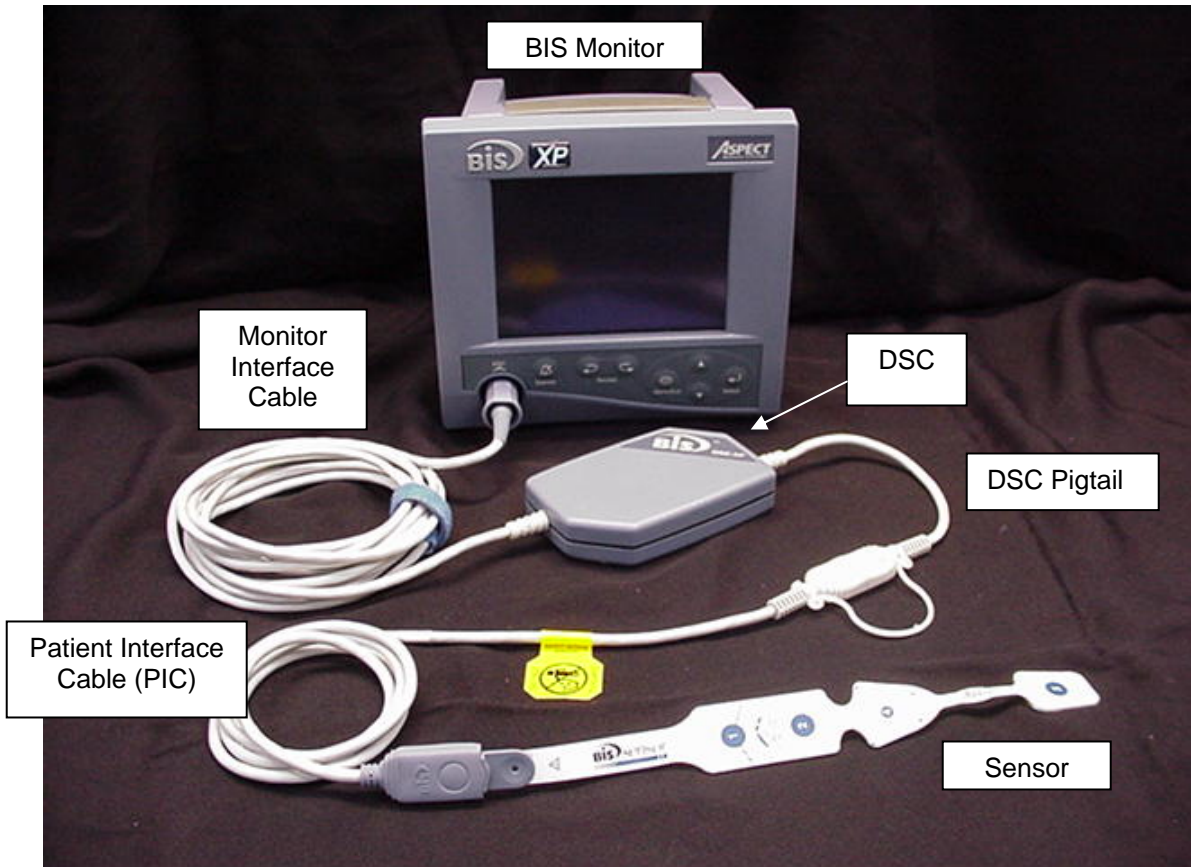

Figure 2-1 The A-2000 BIS Monitoring System

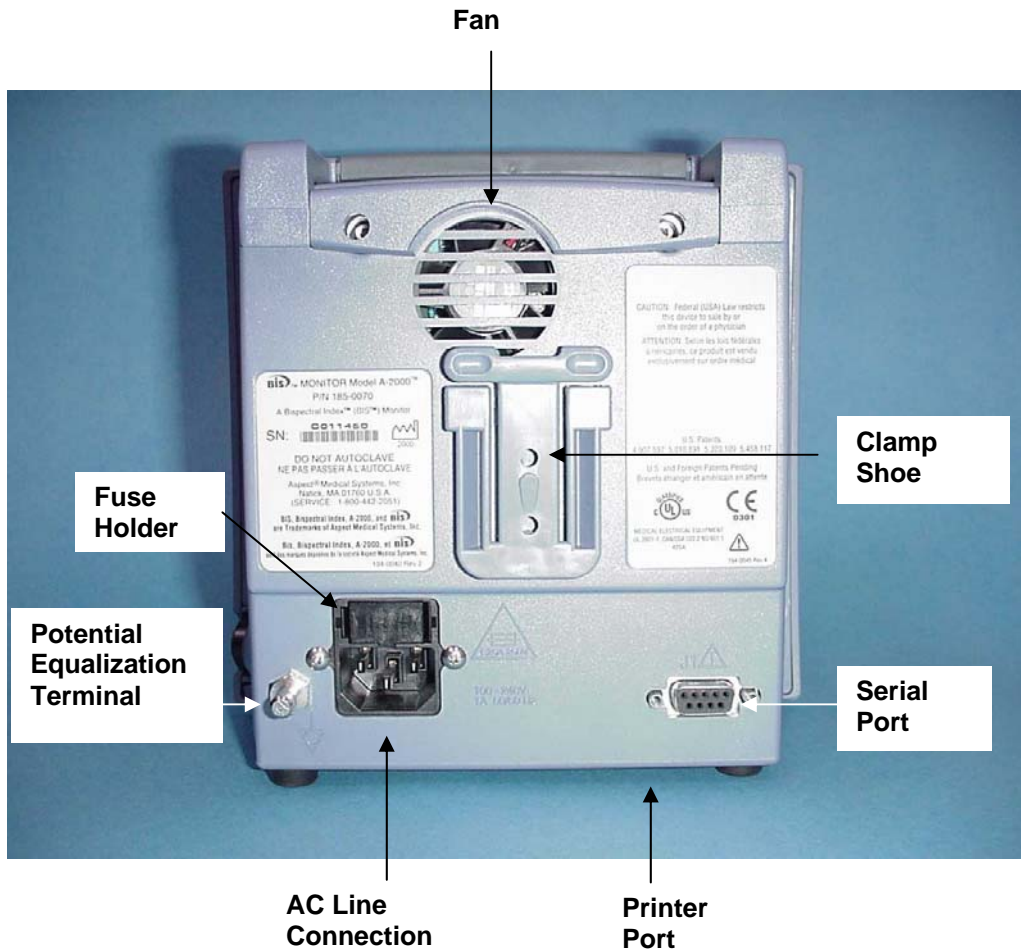

Figure 2-2 Rear View of Monitor

**WARNING**

**REPLACE FUSES ONLY WITH ONE OF THE FOLLOWING PARTS:**

Aspect P/N 430-0006, 1.25 Amps, 250V, 5x20mm

Littelfuse 217 Series, 1.25 Amps, 250V, 5x20mm

Wickmann 193 Series, 1.25 Amps, 250V, 5x20mm

**ALWAYS REPLACE BOTH FUSES TOGETHER, EVEN IF ONLY ONE HAS FAILED.**

## **SECTION III**

### **3 PRINCIPLES OF OPERATION**

#### **INTRODUCTION**

This section includes:

- How the A-2000 BIS Monitoring System works
- The architecture of the A-2000 monitor and DSC
- System Features

#### **3.1 HOW THE A-2000 MONITORING SYSTEM WORKS**

Sensors placed on the patient's head transmit EEG signals to the Digital Signal Converter. The DSC amplifies and digitizes these signals, then sends them to the monitor. The monitor software filters the data, analyzes it for artifact, and processes it using digital signal processing techniques. The purpose of processing the EEG waveform data is to extract characteristic features from the complex signal in order to provide easier pattern recognition of changes over time during the recording.

The A-2000 BIS Monitoring System consists of:

- The BIS monitor with built-in battery backup and detachable power cord
- The Digital Signal Converter (DSC)
- Aspect's BIS Sensor Patient Interface Cable (PIC) and BIS Sensor

#### **3.2 SYSTEM ARCHITECTURE**

Hardware is divided into three main components: the monitor, the digital signal converter (DSC) and the Patient Interface Cable (PIC) with BIS Sensor. The A-2000 monitor contains the circuits for monitor control, digitally processing the EEG data, computing the processed parameters, and displaying the waveforms and processed parameters. The circuits to acquire and digitize the EEG signals reside in the Digital Signal Converter (DSC). The PIC and Sensor are the patient connection for EEG signal acquisition.

A block diagram depicting the monitor subassemblies appears in Figure 3-1. A signal flow diagram appears in Figure 3-2.

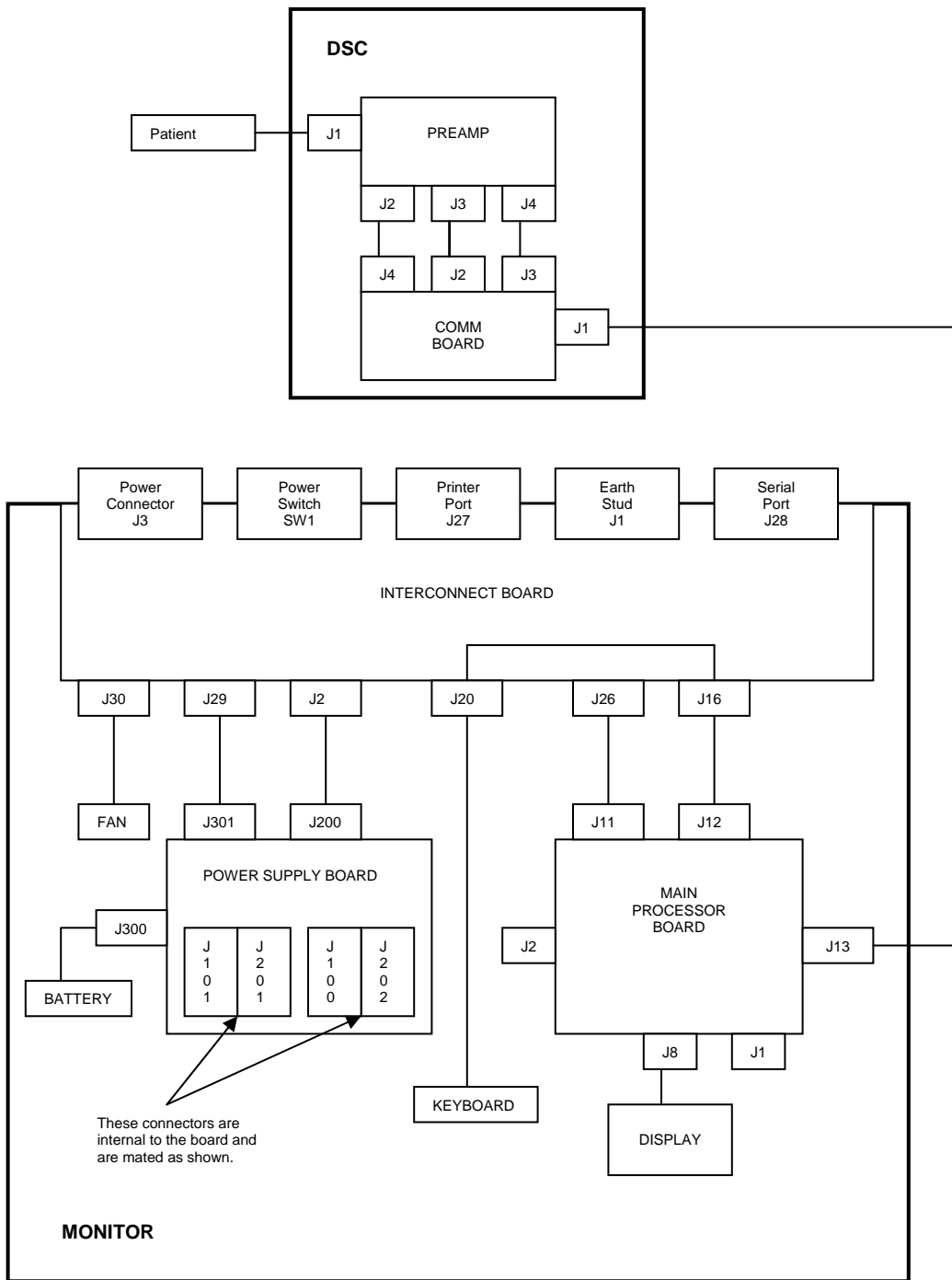
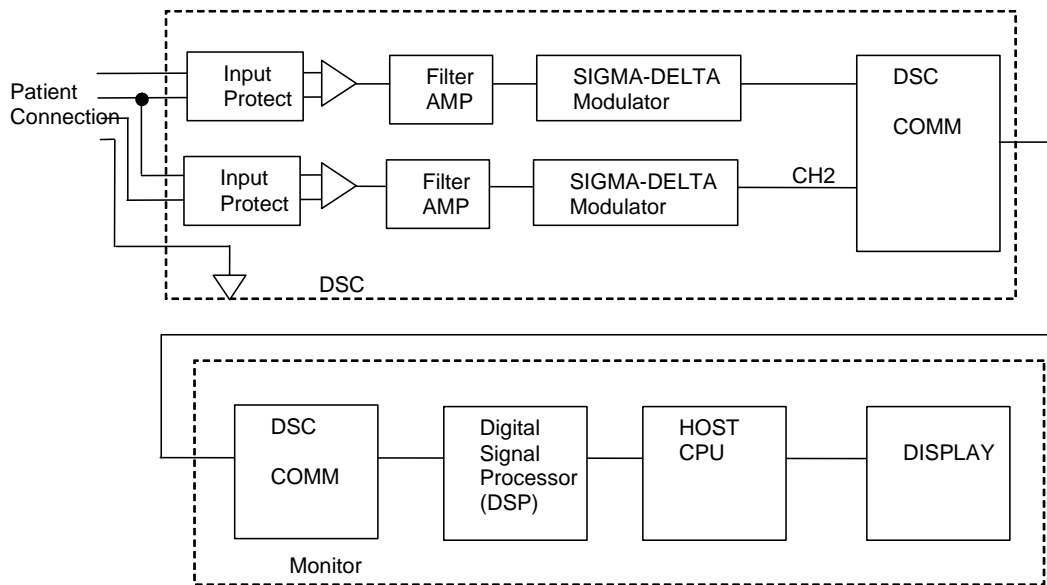

Figure 3-1 The A-2000 System Block Diagram



**Figure 3-2 The A-2000 Signal Flow Diagram**

After passing through input protection circuits in the DSC, the EEG signals are differentially amplified and filtered to remove DC and high frequency components. The signals are digitized by separate one bit sigma-delta analog to digital converters. The outputs from the converters are multiplexed onto the DSC communications line and de-multiplexed in the monitor prior to being fed to the Digital Signal Processor (DSP). The DSP filters the signals and computes the processed variables. The results are passed to the host CPU for display.

### 3.2.1 The Digital Signal Converter (DSC)

The DSC contains the inputs, amplifiers, and digitizers for two channels of EEG. It has a single point connection that connects via a Patient Interface Cable (PIC) to a BIS Sensor. The sensor and PIC contain circuits for identifying them to the monitor. This permits the monitor to configure automatically.

The DSC constantly monitors the combined source impedance at its inputs, and also has facility for measuring the individual impedance of the channel and ground electrodes. There are circuits for injecting self-test voltages into the amplifier inputs.

#### 3.2.1.1 The DSC Preamplifier Circuits

The preamplifier circuits contain the input protection circuits, montage mode switches, differential amplifiers, filter and gain amplifiers, impedance test circuits, self test circuits, and parts of the sensor ID circuit.

#### 3.2.1.2 DSC Signal Conditioning

The input protection circuits are designed to protect the inputs from destruction by electric shock from sources such as electrostatic discharge (ESD) or defibrillation. The protection circuits also reduce the effects of high frequency ambient noise from sources such as electro-cautery and other devices.

The montage mode switches follow the protection circuits. These switches configure the inputs appropriately for the sensor. The signals are amplified by instrumentation amplifiers, which have a fixed gain. The amplifiers have DC servos, which remove the signals below high pass cutoff frequency. In the event of amplifier overload, the servos are changed to a higher frequency to facilitate fast recovery (blocking) under control of the host processor.

Each channel is further amplified to the level required by the A/D converters. The amplifiers also serve as filters to prevent aliasing by the converters.

#### 3.2.1.3 DSC Impedance Testing

In the default state of the DSC the combined channel electrodes' impedance is continuously checked. A small current (approximately 1 nanoampere) is injected into each electrode at 128 Hz, just above the EEG band. The resulting voltages are measured. Equal but opposite currents are injected into the (+) and (-) electrodes simultaneously while the digital signal processor measures the resulting voltage. BIS monitoring is performed while combined impedance is checked.

The DSC can also measure the individual electrode impedance by injecting current into the REF electrode only. Individual electrode impedance is derived by subtracting the resulting value from the combined value. BIS monitoring is interrupted while individual impedance is checked.

The ground electrode impedance is also measured while injecting current into the REF electrode. BIS monitoring is interrupted while the ground impedance is checked.

The impedance check signal can occasionally interfere with other monitoring equipment connected to the patient. Evoked potential monitors are particularly susceptible because they use a wide bandwidth. The automatic impedance check feature can be turned off by selecting "Impedance Checking – OFF" in the Diagnostics Menu (See Operating Manual for specific instructions).

### 3.2.1.4 The DSC Communications Circuits

The communications circuits contain the analog to digital (A/D) converter for each channel, the monitor interface, the sensor interface and the power supply circuits. A crystal controlled DSC master clock is on this board. This clock is the system's BIS processing clock.

#### **A/D Conversion** (Patented technology)

The communications board contains sigma-delta modulators for the two channels. These run at 16384 samples per second.

#### **Test Signal**

A calibrated test signal is generated on the communications board during DSC self test. The signal is a 2 Hz square wave of approximately  $\pm 50\mu\text{V}$ . It is applied to the inputs of the differential amplifiers, resulting in a test of the entire signal path except for the input connections and protection circuits. During self test noise, gain and frequency response are checked.

#### **Interface to the Monitor** (Patented technology)

The outputs from the two channels are multiplexed in a field programmable gate array (FPGA). Multiplexed with the EEG data is status information such as DSC identification, mode (bipolar or referential), lead off indication, and power supply faults. The status information is only transmitted on command from the host. The output is transformer coupled onto a balanced twisted pair line. The transformer provides the required patient isolation.

The communications board decodes the control information coming from the host via a command line. Commands such as "block" amplifier saturation and conduct impedance tests are transmitted.

#### **DSC Power Supply** (Patented technology)

The DSC derives power from the command line. The line is balanced twisted pair coupled via a transformer on the communications board. The isolated signal is rectified and linearly regulated to provide DSC power.

### 3.2.1.5 The DSC Mechanicals

The DSC is contained in a small custom designed plastic case about the size of a computer mouse (see Figure 2-1). It is connected to the monitor via a narrow, highly flexible cable. The case has one large eyelet at the corner to allow the user to use a strap to hang the DSC or pin it to the bed sheets. The patient connection is accomplished with an Aspect BIS Sensor for low and balanced impedance. The Patient Interface Cable pigtail and the monitor cables are strain relieved and permanently attached to the case. A proprietary connector is used for the patient interface cable connection and a high quality plastic connector is used for connection to the monitor.

There are no ventilation holes in the DSC case. It will not leak when splashed with liquids. The case is electrically shielded both to prevent spurious emissions from the DSC and to prevent externally caused interference with the DSC circuits.

### 3.2.2 The A-2000 Monitor

The A-2000 monitor contains the circuits for digitally processing the EEG data, computing the processed parameters, and displaying the waveforms and processed parameters.

The monitor also contains the circuits for powering the monitor, DSC, and companion printer. Printer function is not available on battery backup.

A block diagram depicting the monitor subassemblies appears in Figure 3-1. A signal flow diagram appears in Figure 3-2. The signals are acquired and digitized by the DSC. The DSC multiplexes the signals onto the DSC communications line. The EEG signals are de-multiplexed in the monitor and fed to the Digital Signal Processor (DSP). The processor filters and down-samples them, calculates the processed parameters, and outputs the data display.

#### 3.2.2.1 The Main Board

The Main board contains the Digital Signal Processor, the Host processor, FPGA (field programmable gate array), data memory, real time clock, and DSC interface.

#### 3.2.2.2 Digital Signal Processor

The functions of the DSP include: decimation filters for up to 2 channels of EEG data, computation of processed EEG parameters, control of the DSC, and interface with the host.

#### 3.2.2.3 Host Processor

The functions of the host processor include: control of the display, interface with the keypad, serial port, and printer, control of monitor boot up and download, control of memory.

An on board annunciator is included for generating alarm sounds.

The display interface is a 4-bit LCD type.

The serial port is standard RS-232. This port is used to communicate between the A-2000 and an attached device. The device may be a data capture computer (PC) or a software upgrade device. Software and firmware can be downloaded through this serial port.

The printer interface is a non-standard serial type with extra lines for printer keys and printer control and status. It is designed to interface with a Seiko printer interface board.

#### 3.2.2.4 The Digital Signal Converter (DSC) Interface

The DSC interface is composed of two unidirectional bi-phase encoded serial lines, one going to the DSC and another bringing data from the DSC.

The power to the interface is under software control. An overcurrent detector circuit monitors current to the DSC. If the current exceeds the expected value, the power is shut off to the DSC by the hardware, and the DSP, the Host, and the user are notified.

#### 3.2.2.5 The Interconnect Board

The A-2000 monitor is designed with a minimum of internal cabling. The Interconnect board provides the physical mounting and electrical connections for the major subassemblies of the A-2000. It has mounted to it the power input module (connector for the AC power cord and associated fuses), the equipotential stud, the power switch, and connectors for the printer (external), the serial port (external) and the various internal connectors for the Main PCB, Switch pad, battery, and fan.



### 3.2.2.6 The Power Supply

The power supply runs from AC power from 100-240 VAC, 50-60 Hz. It provides +5 V (at 6 A) and +12 V (at 0.72 A) outputs and charges the battery (6-cell NiMH) 7.2 V (nominal), 1800 mA. Signals are provided to the processor to indicate AC FAIL, RESET, and LOW BATTERY.

### 3.2.2.7 The Battery

The battery is for backup use only. The battery is a six-cell arrangement including temperature and current control elements, and has a nominal output of 7.2 volts DC. The battery is charged only when the A-2000 Monitor is turned on and running from AC power. It is capable of supporting monitor operation for a minimum of 20 minutes. Printer use is not enabled during battery operation. The battery's life expectancy is approximately 5 years or 200 charge and discharge cycles, whichever occurs first.

### 3.2.2.8 The Fan

A fan is located on the rear panel of the chassis. The fan keeps the temperature rise inside the chassis to within approximately 10 degrees of the ambient temperature.

## 3.2.3 A-2000 Printer

The printer is fastened to the monitor bottom and is connected mechanically and electrically (no cable required). The printer interface is compatible only with the optional A-2000 printer. See the A-2000 Printer Operating Manual for details.

## 3.3 SYSTEM FEATURES

### 3.3.1 System Self Checks

The A-2000 monitor has several self-checking features to ensure that the system is operating properly. These include:

#### **System Check**

Initiated when the unit is powered on, this test makes certain that system software and hardware components are functioning properly.

#### **Equipment and Connection Checks**

The system checks continuously to be sure that the DSC, the PIC, and patient sensors are operating properly and have not become disconnected.

#### **DSC Self-Test**

The Digital Signal Converter self-test is a thorough test of the entire signal processing chain including the signal processing computers. The DSC self-test may be initiated in the Diagnostic Menu (see Section 6.2.2).

#### **Display Self-Test**

This self-test, also found in the Diagnostic Menu (see Section VI), performs a thorough test of the screen display functions. This test will not be performed while the monitor is operating on battery backup.

**Impedance Check**

Electrode impedance is tested when the DSC and PIC are connected and is monitored continuously unless the user has turned impedance checking off in the Diagnostic Menu.

**Caution:**

**Continuous impedance checking may need to be disabled if the 1 nanoampere 128 Hz impedance check signal interferes with other equipment, e.g., evoked potential monitors.**

**Diagnostics**

The A-2000 provides diagnostic codes to assist the user in tracing the source of many problems that may occur. Codes are displayed in the right corner of the message region only if the user has selected them in the Diagnostic Menu.

**3.3.2 Data Memory**

The monitor stores recorded trend data with time and date of acquisition. The duration of trend data stored is approximately 11-12 hours. Trend memory can be viewed on the screen in 1-hour segments using the Review arrow keys [←] [→] to scroll through memory. When the memory is full, the oldest data are automatically erased as new data are stored. Memory will be retained even if the battery has been discharged and remains when the monitor is in the power off condition.

**3.3.3 Saved Settings**

The A-2000 monitor will always power up configured to the settings that have been saved in the Advanced Setup Menu.

**3.3.4 Battery Operation**

In the event of a power failure or interruption of power during a procedure, the monitor automatically switches to back-up battery operation. During battery operation, a battery symbol appears in the BIS numeric region of the display. A fully charged battery will provide a minimum 20 minutes of operation. The thermal printer is disabled during battery operation. The battery symbol blinks to alert the user when only a few minutes of back-up power remain. The Save Settings feature is disabled when the battery symbol is blinking. Battery recharge time is approximately 4 hours.

**NOTE:**

The monitor must be powered ON to recharge the battery.

**3.3.5 Data Transfer and Software Updates**

Data may be transferred to and from the A-2000 monitor using the Serial port on the back panel. Request the Aspect A-2000 Serial Port Specification (P/N 070-0017) for a complete description of the protocols. This port is also used to easily upgrade system software.

**WARNINGS:**

**THE USE OF ACCESSORY EQUIPMENT NOT COMPLYING WITH THE EQUIVALENT SAFETY REQUIREMENTS OF THIS EQUIPMENT MAY LEAD TO A REDUCED LEVEL OF SAFETY OF THE RESULTING SYSTEM.**

**CONSIDERATION RELATING TO THE CHOICE SHALL INCLUDE:**

- **USE OF THE ACCESSORY IN THE PATIENT VICINITY**
- **EVIDENCE THAT THE SAFETY CERTIFICATION OF THE ACCESSORY HAS BEEN PERFORMED IN ACCORDANCE TO THE APPROPRIATE IEC 601-1 AND/OR IEC 601-1-1 HARMONIZED NATIONAL STANDARD.**

**WHEN CONNECTING EXTERNAL EQUIPMENT (e.g., DATA CAPTURE COMPUTER), THE SYSTEM LEAKAGE CURRENT MUST BE CHECKED AND MUST BE LESS THAN THE IEC601-1-1 LIMIT.**

**NOTE:**

When software is upgraded, all previously recorded data and monitor configuration settings will be lost. Therefore, configuration settings should be recorded before the software update is performed.

### 3.3.6 Printed Reports

A printer port connector allows connection to the Aspect thermal printer.



**SECTION IV****4 PREPARATION FOR USE AND INSTALLATION****INTRODUCTION**

This section provides an overview of installation information for service personnel working with the Aspect A-2000 BIS Monitor System. Please see the A-2000 BIS Monitoring System Operating Manual for full installation instructions.

- Environment
- Instrument connections
- Installation and verification procedure

**4.1 ENVIRONMENT****4.1.1 Shipping and Storage Environment**

The monitor and its accessories can be stored or shipped within the following environmental limits. Note that these limits apply to non-operational storage and shipping situations.

Temperature	-20 °C to +60 °C
Humidity	15 % to 95 % (non-condensing)
Pressure	360 mmHg to 800 mmHg

Protect the monitor from sudden temperature changes that can lead to condensation within the instrument. To minimize condensation, avoid moving the system between heated buildings and outside storage. Once moved inside, allow the monitor to stabilize in the unopened shipping container at the inside ambient temperature before unpacking and placing into service. Before operation, wipe down all visible condensation and allow the system to reach equilibrium at room temperature.

**4.1.2 Operating Environment**

The A-2000 is not designed for use in areas containing flammable gases or vapors.

**WARNING:**

**EXPLOSION HAZARD: DO NOT USE THE A-2000 IN A FLAMMABLE ATMOSPHERE OR WHERE CONCENTRATIONS OF FLAMMABLE ANESTHETICS MAY OCCUR.**

**MONITOR IS NOT DESIGNED FOR USE IN MRI ENVIRONMENT.**

**Temperature.** The Aspect A-2000 Monitor is designed to operate safely at a room temperature of 5 degrees C to 40 degrees C. Conditions that exceed these limits could affect reliability.

**Humidity.** The monitor is designed to operate within specifications at a relative non-condensing humidity of 15% to 95%.

**Pressure.** The monitor will operate satisfactorily at or above sea level, and is unaffected by extremes or changes in altitude within atmospheric pressures of 360 mmHg to 800 mmHg.

### 4.1.3 Power Requirements and System Grounding

The A-2000 BIS Monitor requires a power source of 100-240 VAC, 50-60Hz. Current consumption is 1 ampere maximum (including printer load).

To protect operating personnel and patients, the monitor must be properly grounded. Accordingly, the monitor is equipped with a hospital grade line cord. The power cord grounds the system to the power line ground when plugged into an appropriate 3-wire receptacle.

**WARNING:**

**FOR PROPER GROUNDING, THE POWER RECEPTACLE MUST BE A THREE-WIRE GROUNDED OUTLET. A HOSPITAL GRADE OUTLET IS REQUIRED. NEVER ADAPT THE THREE-PRONG PLUG FROM THE MONITOR TO FIT A TWO-SLOT OUTLET. IF THE OUTLET HAS ONLY TWO SLOTS, MAKE SURE THAT IT IS REPLACED WITH A THREE-SLOT GROUNDED OUTLET BEFORE ATTEMPTING TO OPERATE THE MONITOR.**

**IF THE INTEGRITY OF THE EXTERNAL PROTECTIVE EARTH GROUND IS IN DOUBT, THE A-2000 SHALL BE OPERATED FROM ITS INTERNAL BATTERY POWER SOURCE ONLY.**

**FOR A-2000s USED OUTSIDE OF NORTH AMERICA: A HARMONIZED LINE CORD WITH CONDUCTORS HAVING A CROSS SECTIONAL AREA GREATER THAN 0.75 MM<sup>2</sup> MUST BE USED.**

### 4.1.4 Site Preparation: Mounting the Monitor

Aspect Medical Systems, Inc. strongly recommends permanent mounting of the A-2000 monitor to the anesthesia machine to enhance safety and facilitate ease-of-use. Please contact your local representative or Aspect to discuss mounting options.

**WARNING!**

**BE SURE THE MONITOR IS MOUNTED SECURELY IN PLACE TO AVOID PERSONAL OR PATIENT INJURY.**

#### 4.1.4.1 Direct Shelf Mounting

The A-2000 has a centrally located screw hole on its underside, in which a #10-24 machine screw can be used to secure the monitor to a shelf (via through-hole). Engagement length of this screw hole is .23 inches (.58 cm). If a printer is attached, use the holes on the underside of the printer.

#### 4.1.4.2 Mounting the Monitor using the Pole Clamp

To mount the monitor to a secure vertical pole (1/2" - 1½" in diameter):

1. Place pole within clamp bracket and tighten screw using the black finger knob. Make sure that there is enough space above the clamp so that you have a few inches to slide the monitor in from above.
2. Line up the clamp shoe (on back of monitor) with the slot on pole clamp and slide monitor down to fit. The bottom of the clamp shoe should be seen well below the bottom of the pole clamp, and the monitor should snap securely into place.

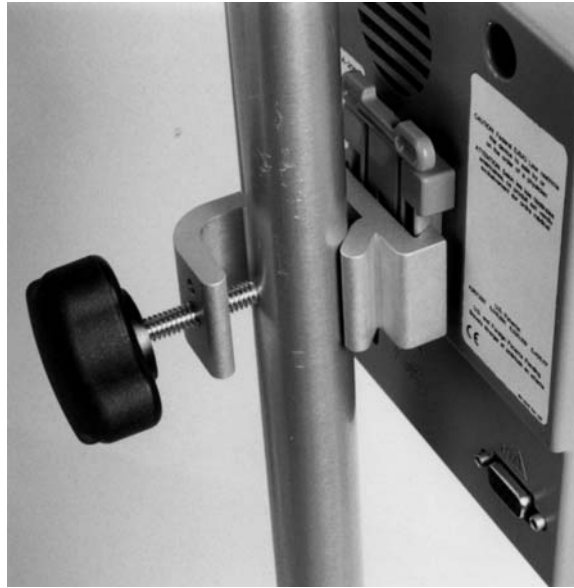

**Figure 4-1 Pole Clamp**

To remove the monitor, press tab on top of clamp shoe before sliding monitor up.

The pole clamp may be locked onto the monitor so that the two do not get separated. To do this:

1. Line up the clamp shoe (on back of monitor) with the slot on pole clamp and slide monitor down to fit. The bottom of the clamp shoe should be seen well below the bottom of the pole clamp and the monitor should snap securely into place.
2. Make sure that set screw hole on pole clamp aligns with corresponding hole on clamp shoe.
3. Remove black knob screw from pole clamp.
4. Using the Allen wrench supplied, secure pole clamp to monitor with the set screw provided.
5. Replace black knob screw.
6. To attach to pole, place pole within clamp bracket and tighten screw using the black finger knob.

#### **4.1.4.3 Optional Mounting Accessories**

For information on optional mounting accessories, request Aspect's "Monitor Mounting Solutions" booklet (part number 070-0031)

## **4.2 INSTRUMENT CONNECTIONS**

Detailed connection instructions are provided in the A-2000 Operating Manual.

#### 4.2.1 Digital Signal Converter Connections

The long flexible cable from the A-2000 Digital Signal Converter connects to the electrically isolated digital signal converter connector on the front panel of the monitor. Once connected, the DSC need not be disconnected again. However, if you wish to disconnect the DSC cable from the monitor, carefully pull on the blue rubber overlay. DO NOT twist or pull on the gray cable.

#### 4.2.2 Power Cord Connections

The A-2000 is designed to use only 3 - conductor IEC hospital-grade power cords. Cords must be type SJE, SJT, or SJO. Check for a firm connection.

#### 4.2.3 Printer Connector

This printer port connector is designed to connect only to the Aspect A-2000 printer for screen prints. To connect:

1. Turn OFF the monitor.
2. If a cover is present on the printer connector, gently remove cover by prying loose one end and pulling free.
3. Align the printer connectors located on the bottom of the monitor and top of the printer so that they mate correctly.
4. Secure the printer to the monitor with the mounting screw located in the base of the printer. Use caution not to cross-thread the mounting screw.
5. Turn on the monitor.



### 4.3 INSTALLATION AND VERIFICATION PROCEDURE

1. Open packages and inspect for all components:
  - Monitor with power cable
  - DSC (Digital Signal Converter)
  - PIC (Patient interface cable)

You will also need a BIS Sensor or Sensor Simulator.
2. Connect power cable to monitor, plug power connector into appropriate wall outlet.
3. Power up monitor by pressing power button (lower right side of case).
  - Verify beep tone as power button is activated
  - Verify fan (rear case wall) moves air outward.
  - Verify that self-test procedure completes successfully (approx. 30 seconds).
  - Verify next screen says 'CONNECT DSC CABLE TO FRONT OF MONITOR'
4. Connect DSC with PIC and Sensor (Refer to the A-2000 Operating Manual for detailed instructions), or with PIC and Sensor Simulator (See this manual, Section 9.2).
  - Verify that DSC test completes
  - Verify SENSOR CHECK screen displays.
5. Exit from SENSOR CHECK screen by passing impedance check or by exiting with MENU/EXIT key.
6. Disconnect power cord.
  - Verify 'OPERATING ON BATTERY BACKUP (E33)' is displayed.
  - Verify battery icon displays in BIS banner (top left corner of screen).
7. Reconnect power cord.
  - Verify battery icon is not displayed in BIS banner.
  - Verify no 'OPERATING IN BATTERY BACKUP (E33) DISPLAY
8. Do keyboard checkout:
 

<ul style="list-style-type: none"> <li>• Press SILENCE key</li> <li>• Press Review ARROW BACK key</li> <li>• Press MENU/EXIT key</li> <li>• Press Review ARROW AHEAD key</li> <li>• Press MENU/EXIT key</li> <li>• Press MENU/EXIT key</li> <li>• Press DOWN ARROW key</li> <li>• Press UP ARROW key</li> <li>• Press SELECT key</li> <li>• Press MENU/EXIT</li> </ul>	<ul style="list-style-type: none"> <li>Verify icon shows at BIS banner</li> <li>Verify REVIEW MODE Menu displays</li> <li>Verify REVIEW MODE MENU exits</li> <li>Verify REVIEW MODE Menu displays</li> <li>Verify REVIEW MODE MENU exits</li> <li>Verify Setup Menu displays</li> <li>Verify highlight bar moves down with each press.</li> <li>Verify highlight bar moves up with each press.</li> <li>Verify that highlighted menu line is selected.</li> <li>Verify that Setup Menu exits</li> </ul>
--	---
9. End of procedure.



**SECTION V****5 PREVENTIVE MAINTENANCE, CARE AND CLEANING****INTRODUCTION**

This section describes:

- Care and cleaning procedures
- Preventive maintenance

**5.1 CARE AND CLEANING****WARNING:**

**UNIVERSAL PRECAUTIONS SHALL BE OBSERVED TO PREVENT CONTACT WITH BLOOD OR OTHER POTENTIALLY INFECTIOUS MATERIALS. PLACE CONTAMINATED MATERIALS IN REGULATED WASTE CONTAINER.**

**5.1.1 Cleaning the Monitor and Digital Signal Converter**

Clean any spillage of blood or solutions on either the monitor or Digital Signal Converter as soon as possible. Dried blood is very difficult to remove. Use lint-free absorbent towels for spill cleanups. Dampen the towel with detergent and lukewarm water to aid in cleaning. After cleaning, dry all areas with a lint-free absorbent paper towel. Wipe Pigtail to PIC cable connector with alcohol and allow to dry completely. Residual moisture inside the connector may affect DSC performance.

**5.1.2 Disinfecting the Monitor and Digital Signal Converter**

Use lint free absorbent towels dampened with 10% bleach solution, or a commercial disinfectant (e.g. Lysol Professional Disinfectant Foam Cleaner Spray or PDI Germicidal Disposable Wipes).

After cleaning, dry all areas except the monitor display screen (see below) with a lint-free absorbent paper towel. Wipe the PIC and DSC pigtail connector ends with alcohol and allow to dry completely.

**WARNING:**

**WHENEVER AN EVENT SUCH AS SPILLAGE OF BLOOD OR SOLUTIONS OCCURS, RE-TEST GROUND LEAKAGE CURRENT BEFORE FURTHER USE.**

**DO NOT MIX DISINFECTING SOLUTIONS (e.g. BLEACH AND AMMONIA) AS HAZARDOUS GASES MAY RESULT.**

**Caution:**

**Do not autoclave the Digital Signal Converter or Monitor. Autoclaving will seriously damage both components.**

**Avoid liquid ingress to the PIC. Contact of fluids with the PIC sensor connectors can interfere with PIC performance.**

**5.1.3 Cleaning the Monitor Display**

Clean the monitor display screen with a mild solution of detergent and warm water, or a commercial display screen cleaner, available through personal computer dealers. Clean with a moist cloth – wring out cloth first. To avoid scratching the screen, never use abrasive cleaners.

## 5.2 PREVENTIVE MAINTENANCE

The A-2000 monitor is designed so that no periodic adjustment or calibration is required. The following procedures should be performed periodically to ensure that the A-2000 is functioning properly.

### 5.2.1 Checking the Battery

The battery must be tested periodically to verify that the A-2000 will continue to operate during power outages. To test:

1. Charge the A-2000 by leaving it plugged in with the power ON for 4 hours.

**Note:**

The monitor must be powered ON to recharge the battery.

2. Disconnect the A/C cord from wall supply
3. Verify that the A-2000 operates reliably for a minimum of 20 minutes.
4. Recharge the battery.

**Caution:**

**Periodically check the battery by operating an A-2000 that has been disconnected from the wall socket and which has been charging the battery for at least four hours. After long periods of storage (e.g. > 1 month) it may be necessary to cycle (discharge, then charge) the battery a few times to get full charge capacity. If the A-2000 fails to operate reliably from the battery for twenty minutes, battery replacement is required.**

**The A-2000 contains an internal Nickel-Metal-Hydride battery. The battery must be removed by a qualified service technician and disposed of or recycled in accordance with the national laws of the country. Contact Aspect Medical Systems, Inc. or the local distributor for servicing of battery.**

**WARNING:**

**ELECTRICAL SHOCK HAZARD: DO NOT REMOVE MONITOR COVERS DURING OPERATION OR WHILE POWER IS CONNECTED TO MONITOR.**

**GROUND WIRE LEAKAGE CURRENT MUST BE CHECKED WHENEVER INSTRUMENT CASE IS OPENED BY A QUALIFIED BIOMEDICAL ENGINEERING TECHNICIAN.**

### 5.2.2 Checking Leakage Current

Leakage current is a primary indicator of electrical shock hazard to personnel making contact with any exposed outer surface of the equipment. Each A-2000 BIS Monitor is carefully checked at the factory to verify that leakage current meets the UL2601 and IEC601-1 safety standards.

**The A-2000 should be routinely checked for leakage current at least once a year.** (See Appendix I). Always check the leakage current after a saline or blood spill, or immediately after a major surge in the house electrical system and after every time the monitor case has been opened.

Keep in mind that liquids such as saline and Ringer's as well as blood are all excellent conductors of electricity. Avoid touching any part of the system with wet hands. Always work with clean, dry hands.

**WARNINGS:**

**SHOCK HAZARD: DO NOT ATTEMPT TO DISCONNECT THE POWER CORD WITH WET HANDS. MAKE CERTAIN THAT YOUR HANDS ARE CLEAN AND DRY BEFORE TOUCHING THE POWER CORD.**

**ELECTRICAL SHOCK HAZARD: THE MANUFACTURER'S INSPECTION OF THIS APPARATUS VERIFIED THAT THE GROUND LEAKAGE CURRENT AND THE PATIENT SAFETY CURRENT WERE LESS THAN THE SPECIFIED LIMITS ESTABLISHED BY THE APPLICABLE SAFETY STANDARDS. AS A MATTER OF SAFE PRACTICE, THE INSTITUTION SHOULD CONDUCT PERIODIC TESTS TO VERIFY THESE CURRENTS.**

**WHENEVER AN EVENT SUCH AS SPILLAGE OF BLOOD OR SOLUTIONS OCCURS, RE-TEST BEFORE FURTHER USE.**

### 5.2.3 A-2000 Monitor System Checkout Procedure

The following test procedure should be performed periodically to ensure that the A-2000 is functioning properly.

<p>IF ANY FAILURES ARE NOTED, SEE <b>STATUS MESSAGES AND OPERATOR ACTIONS</b> SECTION 6.3</p>
---

1. Secure all components.
  - Monitor with power cable
  - DSC
  - PIC (Patient interface cable, connects DSC to patient)
  - BIS Sensor or test sensor or Sensor Simulator.
2. Connect power cable to monitor, plug power plug into appropriate wall outlet.
3. Power up monitor by pressing power switch (right lower side of case).
  - Verify beep tone as power switch is activated.
  - Verify fan (rear case wall) moves air outward.
  - Verify all power on self-tests complete successfully (approx. 30 seconds).
  - Verify next screen says 'CONNECT DSC CABLE TO FRONT OF MONITOR.'
4. Connect DSC with PIC and Sensor (or Test Sensor or Sensor Simulator, see Appendix I).
  - Verify DSC test completes.
  - Verify SENSOR CHECK screen displays.
5. Exit from SENSOR CHECK screen by passing impedance check or by exiting with MENU/EXIT key.
6. Disconnect power cord from rear of monitor.
  - Verify 'OPERATING ON BATTERY BACKUP (E33)' is displayed.
  - Verify battery icon displays in BIS banner.
7. Reconnect power cord.
  - Verify battery icon is not displayed in BIS banner.
  - Verify no 'OPERATING ON BATTERY BACKUP (E33)' is displayed.

8. Perform keyboard checkout:
 

(a) Press SILENCE key	Verify icon shows at BIS banner.
(b) Press ARROW BACK key	Verify REVIEW MODE screen displays.
(c) Press MENU/EXIT key	Verify REVIEW MODE screen exits.
(d) Press ARROW AHEAD key	Verify REVIEW MODE screen displays.
(e) Press MENU/EXIT key	Verify REVIEW MODE screen exits.
(f) Press MENU/EXIT key	Verify Setup menu displays.
(g) Press DOWN ARROW key	Verify highlight bar moves down with each press.
(h) Press UP ARROW key	Verify highlight bar moves up with each press.
(i) Press SELECT key	Verify that highlighted menu line is selected.
(j) Press MENU/EXIT until BIS banner is displayed.	
  
9. Check real time:
  - Press MENU/EXIT key
  - Use the arrows to highlight "Advanced Setup", then press SELECT key.
  - Verify that the time and date are correct for the local area. If incorrect, follow the instructions in Section II of the A-2000 Operating Manual to reset.
  
10. End of checkout.

#### 5.2.4 DSC Checkout Procedure

Periodically the DSC and associated cables and connectors should be inspected for physical damage and verification that the self test will pass.

IF ANY FAILURES ARE NOTED, SEE **STATUS MESSAGES AND OPERATOR ACTIONS** SECTION 6.3

1. Using a known good A-2000 monitor (see section 6.2.1), power up the A-2000 and verify the screen message "Connect DSC Cable to Front of Monitor" displays.
2. Connect the DSC that you are testing and verify the screen message "Connect Sensor to DSC" displays.
3. Perform DSC Self Test. See section 6.2.2
4. Repeat DSC Self test while flexing cables to see if intermittent opens or shorts exist.
5. If PIC and Sensor are available, perform PIC Checkout Procedure. See section 6.2.3.
6. Repeat Sensor check while flexing cable to see if intermittent opens or shorts exist.

#### 5.2.5 Patient Interface Cable (PIC) Checkout Procedure

The Patient Interface Cable (PIC) checkout is done using the A2000 monitor's Sensor Check routine and a Sensor Simulator (see Appendix I, 9.2) or Test Sensor (see Appendix I, 9.3).

IF ANY FAILURES ARE NOTED, SEE **STATUS MESSAGES AND OPERATOR ACTIONS** SECTION 6.3

1. Using a known good A-2000 monitor (see section 6.2.1) and a known good DSC (see section 6.2.2.) connect the PIC to be tested to the DSC and the DSC to the A-2000 monitor.
2. Power ON the A-2000 monitor and DSC. At the completion of the power up self-test, verify that the screen message "Connect Sensor to DSC" displays.
3. Connect a Sensor Simulator (see Appendix 9.2) or Test Sensor (see Appendix 9.3) to the PIC cable. Press firmly together.

4. A sensor check is initiated automatically when the sensor and PIC are connected to the DSC. (It may also be initiated by the user in the Setup Menu.) The impedance value for each electrode, in kilo ohms, appears on the screen along with its status:

**PASS** - An electrode passes if the impedance for that electrode is less than 7.5 kilo ohms. The ground electrode must be less than 100 kilo ohms to pass.

**HIGH** - An electrode is labeled "HIGH" if its impedance value is above 7.5 kilo ohms. As long as the combined impedance is less than 15 kilo ohms, the Sensor Check will be considered successful. If the combined impedance is over the 15 kilo ohms limit, you will need to re-prep the electrodes and check all connections. The monitor will continue to check impedance until it is acceptable.

**NOISE** - If the signal from the electrode goes beyond the measurable range, the label "NOISE" will appear.

**LDOFF** - If a lead is too loose or disconnected, the label "LDOFF" will appear.

5. NOTE: Sensor Check is used in clinical application as an indicator of the patient's skin conductivity. When used with a Sensor Simulator or Test Sensor, it serves the purpose of verifying the DSC and PIC cable conductors. Therefore the status indications called out above need to be interpreted as conditions relating to the DSC and PIC ability to conduct the sensor check signal. Values that are too high must be investigated as possible failures to be repaired.

### Expected Impedance Values

Sensor Simulator Values			Test Sensor Values		
Electrode #	Typical	Range	Electrode	Typical	Range
1	5 K Ohms	4-6 K Ohms	1	1 K Ohms	1-2 K Ohms
2	10 K Ohms	8-17 K Ohms	2	1 K Ohms	1-3 K Ohms
4	4 K Ohms	3-5 K Ohms	4	1 K Ohms	1-2 K Ohms
3	3 K Ohms	2-4 K Ohms	3	1 K Ohms	1-2 K Ohms

6. Repeat the Sensor Check. Press the MENU/EXIT key, then press ARROW key to highlight the SENSOR CHECK line on the menu. Press SELECT key to initiate the Sensor Check routine again. During the Test sequence, flex the cable and connections at the PIC/SENSOR, and PIC/DSC and also the DSC box to Patient end cable. Note that gentle flexing of these cables and connectors should not cause the Sensor Check to fail.

#### 5.2.6 Physical Integrity Inspection

Periodically check the system (A-2000 Monitor, DSC, PIC cable) for physical damage to cases, and associated cables and connectors.

1. Inspect the cases of the monitor and the DSC to insure plastic is not cracked or broken
2. Inspect the gasket seal around the case joining surfaces to insure the integrity of the splash resistance seal.
3. Inspect the cables and strain relief mechanisms.
4. Inspect the connectors for damage, faulty strain relief or contamination.





## SECTION VI

### 6 DIAGNOSTICS AND TROUBLESHOOTING

#### INTRODUCTION

This section explains:

- General troubleshooting using built in diagnostic tools
- BIS Monitor System troubleshooting procedure.
- Status messages, causes, and corrective actions

#### 6.1 GENERAL TROUBLESHOOTING

The A-2000 BIS Monitor System has three built-in diagnostic features:

- Power-Up
- Automatic
- Manual

These features check the BIS Monitoring System's operability, status, and also report software and hardware malfunctions.

IF ANY FAILURES ARE NOTED, SEE **STATUS MESSAGES AND OPERATOR ACTIONS** SECTION 6.3

The **power-up** diagnostics run automatically each time that you turn on the Monitor unit. These procedures check the software, system memory, speaker, display, serial ports, timer/counters, BIS Engine, real-time clock, Data Memory and Setup Memory. This level of diagnostic is described in detail in the monitor's operating manual.

The **automatic** diagnostics run continuously in the background while the unit operates. These procedures check the Digital Signal Converter for the following conditions: interface faults, disconnect, lead off, and power faults. This level of diagnostic also checks other monitor functions; please reference this detail in the monitor's operating manual.

The **manual** diagnostics are operator initiated using the monitor keys and menu choices. These procedures check for the proper functioning of the Digital Signal Converter. This level of diagnostic also can be used to check other monitor functions; please reference this detail in the monitor's operating manual.

#### **NOTE:**

The manual diagnostics can be run safely while the patient is connected to the BIS Monitor unit; however, running the diagnostics will temporarily disrupt monitoring. Do not run DSC self test during electro-cautery as it may erroneously indicate a failure.

## 6.2 A-2000 BIS MONITOR SYSTEM TROUBLESHOOTING PROCEDURE

The A-2000 System consists of three major components: Monitor, DSC, and PIC/Sensor. By using this three-step procedure and a component swapping technique, the component at fault can easily be determined. The steps of this test procedure are:

- Monitor
- DSC recognition and self test
- PIC and Sensor

Following the test procedure is a MESSAGE AND OPERATOR ACTION section that describes appropriate actions for messages that may occur.

See Section 7 for directions on replacing components and handling components that require service.

### 6.2.1 MONITOR Troubleshooting Procedure

**Note:**

The successful completion of this test will verify the monitor is functioning and all operator input (keyswitch) and output (display and audio alarm) are OK.

IF ANY FAILURES ARE NOTED, SEE **STATUS MESSAGES AND OPERATOR ACTIONS** SECTION 6.3

1. Disconnect DSC from Front of Monitor.
2. Connect power cord to rear of monitor, and attach to AC power source.
3. Press POWER ON switch.
  - Verify beep tone as POWER SWITCH is activated.
  - Verify fan (rear case wall) is moving air outward.
  - Verify display shows all self-tests complete successfully (approx. 30 seconds).
  - Verify that at completion of self tests display shows 'CONNECT DSC TO FRONT OF MONITOR'.
  - Verify no battery icon in BIS banner border and no E33 'OPERATING ON BATTERY BACKUP' or E34 'BATTERY LOW' message.

**NOTE:**

Since the A2000 monitor has a built in battery backup, the monitor will power up with no AC power applied. This step assures that this part of the test is performed in AC operation.

**IF ANY FAILURES ARE NOTED:**

- Verify AC power outlet (wall outlet) is supplying AC Volts of 110vac to 240vac at a frequency of 50hz to 60hz. Move power cord to known good outlet.
- Verify AC power cord is good. Swap power cord with known good one.
- Verify A2000 fuses are OK. See section 7.2 for fuse removal, replacement procedure.
- If failure continues after above actions, monitor component will need to be serviced, see section 7.3

4. Unplug the AC power cord from monitor.

**NOTE:**

Since the A2000 monitor has a built in battery backup, the monitor will power up with or without AC power applied. This step assures that this part of the test is performed in Battery operation.

- Verify monitor continues to operate (time depends on state of battery charge).
  - Verify message E33 OPERATING ON BATTERY POWER or E34 BATTERY POWER LOW display.
  - Verify battery icon displays in BIS banner border
5. Reconnect AC power cord to monitor:
    - Verify Monitor continues to operate.
    - Verify E33 and E34 messages do not display.
    - Verify battery icon does not display in BIS banner border.

**IF ANY FAILURES ARE NOTED:**

- Verify AC power outlet (wall outlet) is supplying AC Volts of 110vac to 240vac at a frequency of 50hz to 60hz. Move power cord to known good outlet.
- Verify AC power cord is good. Swap power cord with known good one.
- Verify A2000 fuses are OK. See section 7.2 for removal, replacement procedure.
- If failure continues after above actions, monitor component will need to be serviced, see section 7.3

6. Press each keyswitch on front panel:
  - Verify appropriate response to keyswitch press (See Installation Procedure for details, switch by switch)
7. Press Menu/Exit key, then highlight and select "ADVANCED SETUP". When the Advanced Setup Menu appears, highlight and Select "DIAGNOSTIC MENU". From the Diagnostic Menu, highlight and select "Display Self Test". Press Select to initiate the test.

**Note:**

This test will not be performed when the unit is on battery backup.

- Verify that all Pixels illuminate. If there is a problem, see section 7 for instructions on replacing the monitor.
  - Press Menu/Exit, Menu/Exit.
8. Proceed to DSC section.

### 6.2.2 DSC Troubleshooting Procedure

**Note:**

The successful completion of this test will verify the DSC is recognized and communicates with the monitor. It also verifies the handling circuits are functioning properly to and from the DSC.

IF ANY FAILURES ARE NOTED, SEE **STATUS MESSAGES AND OPERATOR ACTIONS** SECTION 6.3

1. With no Sensor connected, plug DSC into the front of Monitor case.
  - Verify monitor display reads “Connect Sensor to DSC”
2. Press Menu/Exit key, then highlight and Select “ADVANCED SETUP”, then highlight and Select “DIAGNOSTIC MENU”, then highlight and Select “DSC SELF TEST”
  - Verify display shows “DSC Test Results: PASS” (this takes approximately 20 seconds). Note that test results are posted in 4 tests for 2 channels. The numbers are not important, but if the test fails, \*\*\* or the word FAIL will indicate which test is at fault.
3. Press Menu/Exit key, and re-run DSC SELF TEST, this time moving cables, flexing near connectors to check for intermittent connections or conductors. To execute, highlight and select DSC SELF TEST.
  - Verify display shows “DSC Test Results: PASS” (this takes approximately 20 seconds).
4. Press Menu/Exit key until “Connect Sensor to DSC” screen displays.

IF ANY FAILURES ARE NOTED, SEE **STATUS MESSAGES AND OPERATOR ACTIONS** SECTION 6.3

5. Proceed to PIC and Sensor Check.

## 6.2.3 PIC AND SENSOR Troubleshooting Procedure

**Notes:**

The successful completion of this test will verify the BIS system from the DSC circuits to the patient connector. Since the conductors used are located both in the DSC and the PIC, use a swapping technique to isolate the faulty component.

Use a Sensor Simulator or make a Test Sensor for this test. See Appendix I for details.

IF ANY FAILURES ARE NOTED, SEE **STATUS MESSAGES AND OPERATOR ACTIONS** SECTION 6.3

1. Connect Sensor Simulator or Test Sensor to PIC cable.
2. Connect PIC cable to DSC pigtail.
  - Verify that the Sensor Check begins, and each element displays a number, then says PASS.

**Expected Impedance Values**

Sensor Simulator Values			Test Sensor Values		
Electrode #	Typical	Range	Electrode	Typical	Range
1	5 K Ohms	4-6 K Ohms	1	1 K Ohms	1-2 K Ohms
2	10 K Ohms	8-17 K Ohms	2	1 K Ohms	1-3 K Ohms
4	4 K Ohms	3-5 K Ohms	4	1 K Ohms	1-2 K Ohms
3	3 K Ohms	2-4 K Ohms	3	1 K Ohms	1-2 K Ohms

3. Press Menu/Exit, then highlight and select Sensor Check. As Sensor Check executes this time, flex the cables and connectors from the DSC up to the sensor, to check for intermittent connections or conductors.
  - Verify that the Sensor Check begins, and each element displays a number, then says PASS.

**Expected Impedance Values**

Sensor Simulator Values			Test Sensor Values		
Electrode #	Typical	Range	Electrode	Typical	Range
1	5 K Ohms	4-6 K Ohms	1	1 K Ohms	1-2 K Ohms
2	10 K Ohms	8-17 K Ohms	2	1 K Ohms	1-3 K Ohms
4	4 K Ohms	3-5 K Ohms	4	1 K Ohms	1-2 K Ohms
3	3 K Ohms	2-4 K Ohms	3	1 K Ohms	1-2 K Ohms

4. End of procedure.

## 6.2.4 DSC Cable Problem Isolation

**Note:**

This A-2000 Service Information Manual contains the maintenance and diagnostic troubleshooting information necessary for qualified technical personnel to test and replace those parts of the equipment that are replaceable by the customer. Aspect does not authorize nor provide information to service or repair the internal electronic components of the DSC or the A-2000 Monitor.

The qualified user may replace the DSC cables by following the procedures in Chapter 7. In cases of obvious damage, pulled connectors or crushed cables, the need to replace the cables is known. If cables are suspect, the following may be of aid in determining which cable is defective.

**Monitor cable** (monitor connector to DSC box) is a 5-conductor cable that handles all communications to/from the DSC. It uses two twisted pair and a ground for digital data transmission and for the clock transitions that are used to generate power in the DSC housing. Therefore, failure in this cable is usually seen as failure to recognize the DSC (E01 "DSC Not Connected" or E02 "DSC Overcurrent" messages).

**Pigtail cable** (DSC box to PIC connector) is a 10-lead conductor that brings in the patient's EEG signal and also provides information about the sensor connected. If this cable fails, the system may indicate that the sensor is not connected or is illegal, or the Sensor Check may fail or restart on its own.

Please note that all of the Pigtail conductors are also continued through the PIC cable to the sensor. It is important that the PIC cable be eliminated as a potential problem before opening the DSC to change the pigtail cable. They both can generate the same types of faults!

Procedure: Once a problem is isolated to the DSC, use the following sequence to determine the most probable cable:

1. With no sensor connected, run DSC Self test (see section 6.2.2):
  - If test fails or will not start, or the DSC is not recognized, the Monitor cable is likely suspect. This failure may also be related to a PCB problem in the DSC in which case the DSC must be returned to Aspect for Service.
  - If test indicates PASS, continue to step 2.
2. Connect Sensor Simulator or Test Simulator. Run Sensor Check (see section 6.2.3):
  - If failure is noted, swap PIC with known good PIC cable and run again.
  - If failure repeats, the Pigtail cable is likely suspect. This failure may also be related to a PCB problem in the DSC in which case the DSC must be returned to Aspect for service.

**Note:**

A continuity test can be used to verify conductor integrity, use diagrams in Appendix II

**6.3 STATUS MESSAGES AND OPERATOR ACTIONS**

<b><u>Status Messages:</u></b>	<b><u>Causes:</u></b>	<b><u>Corrective Actions:</u></b>
<b>E01 DSC Not Connected</b>	<ol style="list-style-type: none"> <li>1. DSC disconnected.</li> <li>2. Defective DSC cable.</li> <li>3. Defective DSC.</li> <li>4. Defective monitor.</li> </ol>	<ol style="list-style-type: none"> <li>1. Connect DSC. Verify all cable connections.</li> <li>2. Inspect / repair cable at connector end.</li> <li>3. Replace the DSC</li> <li>4. Replace monitor</li> </ol>
<b>E02 DSC Overcurrent</b>	<ol style="list-style-type: none"> <li>1. Defective DSC cable.</li> <li>2. Defective DSC.</li> <li>3. Defective monitor.</li> </ol>	<ol style="list-style-type: none"> <li>1. Replace the DSC.</li> <li>2. Replace the DSC.</li> <li>3. Replace Monitor</li> </ol>
<b>E03 DSC Power Regulation</b>	<ol style="list-style-type: none"> <li>1. Defective DSC.</li> <li>2. Defective DSC cable.</li> </ol>	Replace DSC.
<b>E04, E05, E06, E07, E08 DSC Error</b>	<ol style="list-style-type: none"> <li>1. Defective DSC</li> <li>2. Defective monitor.</li> </ol>	<ol style="list-style-type: none"> <li>1. Replace the DSC.</li> <li>2. Replace the monitor.</li> </ol>
<b>E09 DSC Shut Down</b>	<ol style="list-style-type: none"> <li>1. Electro-cautery equipment used during self-test.</li> <li>2. Defective DSC.</li> <li>3. Defective monitor.</li> </ol>	<p><b>Note:</b> This error requires monitor power down to reset error before each corrective action is performed.</p> <ol style="list-style-type: none"> <li>1. Isolate BIS system from possible noise sources or restart monitor when electro-cautery equipment not in use. (Note that self-test runs when the DSC is first connected.)</li> <li>2. Replace the DSC.</li> <li>3. Replace monitor</li> </ol>
<b>E10 Illegal DSC Type</b>	<ol style="list-style-type: none"> <li>1. Incorrect DSC in use.</li> <li>2. Defective DSC.</li> <li>3. Defective monitor</li> </ol>	<ol style="list-style-type: none"> <li>1. Connect the correct DSC.</li> <li>2. Replace the DSC.</li> <li>3. Replace Monitor</li> </ol>

<b><u>Status Messages:</u></b>	<b><u>Causes:</u></b>	<b><u>Corrective Actions:</u></b>
<b>E11 DSC Failed Self Test</b>	<ol style="list-style-type: none"> <li>1. Electro-cautery equipment used during self-test.</li> <li>2. Defective DSC.</li> <li>3. Defective monitor.</li> </ol>	<ol style="list-style-type: none"> <li>1. Isolate BIS system from possible noise sources or restart monitor when electro-cautery equipment not in use. (Note that self-test runs when the DSC is first connected.)</li> <li>2. Replace the DSC.</li> <li>3. Replace monitor</li> </ol>
<b>E12 Illegal Sensor Type</b>	<ol style="list-style-type: none"> <li>1. Poor or contaminated connection between sensor and PIC.</li> <li>2. Defective sensor.</li> <li>3. Defective PIC.</li> <li>4. Defective DSC.</li> </ol>	<ol style="list-style-type: none"> <li>1. Connect/clean connection between sensor and PIC.</li> <li>2. Replace the sensor.</li> <li>3. Replace the PIC.</li> <li>4. Replace the DSC.</li> </ol>
<b>E13, E15 Re-prep Sensor</b>	<ol style="list-style-type: none"> <li>1. Incorrect sensor application.</li> <li>2. Poor sensor connections.</li> <li>3. Sensor Check fails</li> <li>4. Defective PIC.</li> <li>5. Defective DSC</li> </ol>	<ol style="list-style-type: none"> <li>1. Read Instructions on sensor package and re-apply.</li> <li>2. Check sensor connections.</li> <li>3. Re-prep / replace sensor. Verify Sensor Check passes.</li> <li>4. Replace the PIC.</li> <li>5. Replace DSC</li> </ol>
<b>E14 Sensor Not Connected</b>	<ol style="list-style-type: none"> <li>1. Disconnected sensor</li> <li>2. Poor or contaminated connection between sensor and PIC.</li> <li>3. Disconnected PIC.</li> <li>4. Defective PIC.</li> <li>5. Defective DSC.</li> <li>6. Defective monitor</li> </ol>	<ol style="list-style-type: none"> <li>1. Connect the Sensor</li> <li>2. Connect/clean connection between sensor and PIC.</li> <li>3. Connect the PIC.</li> <li>4. Replace the PIC.</li> <li>5. Replace the DSC.</li> <li>6. Replace the monitor.</li> </ol>
<b>E15 (See E13)</b>		
<b>E16 Last Sensor Check Failed</b>	<ol style="list-style-type: none"> <li>1. At least one element of sensor has too high impedance, and EXIT pressed (before sensor check completes).</li> <li>2. Incorrect sensor application.</li> <li>3. Poor sensor connection.</li> <li>4. Defective PIC.</li> <li>5. Defective DSC.</li> </ol>	<ol style="list-style-type: none"> <li>1. Verify Sensor Check passes.</li> <li>2. Read Instructions on sensor package and re-apply sensor.</li> <li>3. Check sensor connection.</li> <li>4. Replace the PIC.</li> <li>5. Replace the DSC.</li> </ol>



<b><u>Status Messages:</u></b>	<b><u>Causes:</u></b>	<b><u>Corrective Actions:</u></b>
<b>E17, E19, E20, E21, E22, E23, E24 BIS Engine Comm. Error</b>	Error in communication between BIS Engine and Host.	<ol style="list-style-type: none"><li>1. Verify the software level.</li><li>2. Replace the monitor.</li></ol>
<b>E18 BIS Engine Not Functional</b>	Fatal BIS Engine error detected.	<ol style="list-style-type: none"><li>1. Turn monitor off, then on again.</li><li>2. Verify the software level.</li><li>3. Replace the monitor.</li></ol>
<b>E19 - E24 (See E17)</b>		

**EEG Signal (Errors 25 and 26):**

**Note:** These messages relate to the condition of the EEG signal. This signal is often affected by environmental conditions that cause artifact (non-EEG signal). The messages below do not usually indicate a monitor system error; instead they serve as a notification of a patient or environmental condition.

<b><u>Status Messages:</u></b>	<b><u>Causes:</u></b>	<b><u>Corrective Actions:</u></b>
<b>E25 Left Side SQI Bad</b>	<p>With 2-channel montage, left side signal quality is bad.</p> <ol style="list-style-type: none"> <li>1. Artifact is causing EEG information to be lost</li> <li>2. EMG Bar indicates electrical activity that may be interfering with EEG recognition.</li> <li>3. PIC is defective.</li> <li>4. DSC is defective.</li> </ol> <p><b>Note:</b> This message may occur as the result of artifact (non-EEG signal) such as those generated from motion (patient movement) or the presence of electro-cautery or other devices.</p>	<ol style="list-style-type: none"> <li>1. If ARTIFACT label appears in EEG waveform box, attempt to identify and eliminate artifact source.</li> <li>2. If EMG is present, try to determine and eliminate cause.</li> <li>3. Verify Sensor Check passes. If not, replace PIC.</li> <li>4. Replace DSC</li> </ol>
<b>E26 Right Side SQI Bad</b>	<p>With 2-channel montage, right side signal quality is bad.</p> <ol style="list-style-type: none"> <li>1. Artifact is causing EEG information to be lost</li> <li>2. EMG Bar indicates electrical activity that may be interfering with EEG recognition.</li> <li>3. PIC is defective.</li> <li>4. DSC is defective.</li> </ol> <p><b>Note:</b> This message may occur as the result of artifact (non-EEG signal) such as those generated from motion (patient movement) or the presence of electro-cautery or other devices.</p>	<ol style="list-style-type: none"> <li>1. If ARTIFACT label appears in EEG waveform box, attempt to identify and eliminate artifact source.</li> <li>2. If EMG is present, try to determine and eliminate cause.</li> <li>3. Verify Sensor Check passes. If not, replace PIC.</li> <li>4. Replace DSC</li> </ol>

<u>Status Messages:</u>	<u>Causes:</u>	<u>Corrective Actions:</u>
<b>E27</b> <b>SQI Below 50</b>	<p>The Signal Quality Index is less than 50 and the numeric display changes from a solid to an outlined number.</p> <p>This may occur as the result of artifact such as those generated from motion or eyeblinks.</p>	<ol style="list-style-type: none"> <li>1. Re-prepare the sensor.</li> <li>2. Check impedance.</li> </ol>
<b>E28</b> <b>SQI Too Low for BIS</b>	<p>The Signal Quality Index is unacceptable. The Primary Trend variable cannot be calculated and therefore the numeric display is blanked.</p> <ol style="list-style-type: none"> <li>1. Artifact, such as those generated by motion or eyeblinks, is causing loss of EEG recognition.</li> <li>2. EMG Bar indicates electrical activity that may be interfering with EEG recognition.</li> <li>3. PIC is defective.</li> <li>4. DSC is defective.</li> </ol> <p><b>Note:</b> This message may occur as the result of artifact (non-EEG signal) such as those generated from motion (patient movement or eyeblinks) or the presence of electro-cautery or other devices.</p>	<ol style="list-style-type: none"> <li>1. If ARTIFACT label appears in EEG waveform box, attempt to identify and eliminate artifact source.</li> <li>2. If EMG bar is illuminated, attempt to determine and eliminate cause.</li> <li>3. Verify Sensor Check passes. If not, replace PIC.</li> <li>4. Replace DSC</li> </ol>
<b>E29</b> <b>BIS &lt; Low Alarm Limit</b>	<p>The BIS has fallen below the low alarm limit set by the user. The numeric display flashes.</p>	<p>Take note of BIS at limit set by user.</p>
<b>E30</b> <b>BIS &gt; High Alarm Limit</b>	<p>The BIS has risen above the high alarm limit set by the user. The numeric display flashes.</p>	<p>Take note of BIS at limit set by user.</p>

<b><u>Status Messages:</u></b>	<b><u>Causes:</u></b>	<b><u>Corrective Actions:</u></b>
<b>E31 Isoelectric EEG Detected</b>	No discernible EEG activity is detected for several minutes; SR=100. <b>Note:</b> This message notifies user of a flatline EEG. This is a normal condition when Sensor Simulator or Test Sensor is connected.	<ol style="list-style-type: none"> <li>1. Check the patient</li> <li>2. Check leads for proper connection and possible shorts.</li> <li>3. Verify Sensor Check passes.</li> <li>4. Verify DSC - Self-test</li> <li>5. Verify PIC – Use Test Sensor or Sensor Simulator and Sensor Check.</li> </ol>
<b>E32 Review Data Lost</b>	Data memory has been re-initialized.	<ol style="list-style-type: none"> <li>1. Turn the monitor off, then on again</li> <li>2. If error persists, monitor requires service.</li> </ol>
<b>E33 Operating On Battery Backup</b>	The AC power has been lost and the monitor is running on the battery. The battery keeps the monitor operating for approximately 20 minutes (when the battery is fully charged).	<ol style="list-style-type: none"> <li>1. Restore the AC power.</li> <li>2. Verify power cord.</li> <li>3. Verify AC fuses are good.</li> <li>4. Replace monitor.</li> </ol>
<b>E34 Battery Power Low</b>	There are only a few minutes of battery life left.	Restore AC power to avoid automatic shutdown.
<b>E35 - E39, E43, E44, E48 - E65, E69 – E73, E75, E78 – E80, E87- E89 Software Error</b>	A software error has occurred. The monitor may stop operating.	<ol style="list-style-type: none"> <li>1. Turn the monitor off, then on again.</li> <li>2. Verify the software level.</li> <li>3. Replace monitor.</li> </ol>
<b>E40 Setup Memory Write Error</b>	Error in erasing or writing Setup block of FLASH memory.	<ol style="list-style-type: none"> <li>1. Check Setup.</li> <li>2. Replace monitor.</li> </ol>
<b>E41 Real-Time Clock Write Error</b>	Error in writing to Real-Time Clock RAM.	Replace monitor.
<b>E42 Can't Save Setup</b>	Monitor is unable to write to Setup Memory when battery power is low.	<ol style="list-style-type: none"> <li>1. Restore AC power.</li> <li>2. Save settings again.</li> <li>3. Replace monitor.</li> </ol>
<b>E43, E44 (See E35)</b>		

<u>Status Messages:</u>	<u>Causes:</u>	<u>Corrective Actions:</u>
<b>E45 No Updates from BIS Engine</b>	No data received from BIS Engine in last 10 seconds.	<ol style="list-style-type: none"> <li>1. Turn monitor off, then on again.</li> <li>2. Verify the software level.</li> <li>3. Replace monitor.</li> </ol>
<b>E46 BIS Engine Not Responding</b>	BIS Engine has not responded to a command within 12 seconds.	<ol style="list-style-type: none"> <li>1. Turn monitor off, then on again.</li> <li>2. Verify the software level.</li> <li>3. Replace monitor.</li> </ol>
<b>E47, E74, E81 Data Memory Write Error</b>	Error in erasing or writing Data Memory portion of FLASH memory.	Replace monitor.
<b>E48 – E65 (See E35)</b>		
<b>E66 Printer Out of Paper</b>	Printer is out of paper.	Install the paper.
<b>E67, E82, E85 Printer Error</b>	<ol style="list-style-type: none"> <li>1. Printer is off-line.</li> <li>2. Print head is up.</li> <li>3. Printer is disconnected.</li> <li>4. Print head temperature out of range.</li> <li>5. Print head voltages out of range.</li> <li>6. Printer hardware failure.</li> </ol>	<ol style="list-style-type: none"> <li>1. Put printer on-line.</li> <li>2. Close print head.</li> <li>3. Connect printer.</li> <li>4. Replace printer.</li> </ol>
<b>E68</b>	Not used.	
<b>E69 – E73 (See E35)</b>		
<b>E74 (See E47)</b>		
<b>E75 (See E35)</b>		
<b>E76 Illegal Sensor for Demo</b>	A Demo Device has been connected to the serial port, but the PIC is connected to a sensor.	<ol style="list-style-type: none"> <li>1. Disconnect the sensor and connect the PIC to the Demo Device, or:</li> <li>2. Disconnect Demo Device.</li> </ol>
<b>E77 Simulator Connected</b>	A Demo Device has been connected to the monitor.	<b>Note:</b> This is a message rather than an error. No action is necessary.

<b><u>Status Messages:</u></b>	<b><u>Causes:</u></b>	<b><u>Corrective Actions:</u></b>
<b>E78 – E80</b> (See E35)		
<b>E81</b> (See E47)		
<b>E82</b> (See E67)		
<b>E83 Printer Head is Up</b>	The print head on the printer has been lifted.	<ol style="list-style-type: none"> <li>1. Return print head to the closed position.</li> <li>2. If the error persists, the printer requires service.</li> </ol>
<b>E84 Printer Disconnected</b>	The printer is no longer connected to the A-2000.	<ol style="list-style-type: none"> <li>1. Check the connection.</li> <li>2. If the error persists, the printer requires service.</li> </ol>
<b>E85</b> (See E67)		
<b>E86 Printing Disabled</b>	The A-2000 is running on battery backup.	<b>Note:</b> Printer functions only on AC power. When power is restored, printing will again be available.
<b>E87, E88, E89</b> (See E35)		
<b>E90 Printer Connected</b>	The printer has been successfully connected to the A-2000.	<b>Note:</b> This is a message rather than an error. No action is necessary.
<b>E91 Event Marking Disabled</b>	Data extraction is in progress.	<b>Note:</b> Event marking will be re-enabled when event data extraction has been completed (less than 10 minutes).
<b>E92</b>	Not used	
<b>E93 Sensor Ground Fault</b>	Problem is detected relating to sensor ground element.	<ol style="list-style-type: none"> <li>1. Disconnect and examine sensor connection. Clean any contamination present.</li> <li>2. Replace sensor if necessary.</li> <li>3. Replace PIC.</li> <li>4. Replace DSC.</li> </ol>
<b>E94 Sensor Overcurrent</b>	Sensor is using too much current.	<ol style="list-style-type: none"> <li>1. Disconnect and examine sensor connection. Clean any contamination.</li> <li>2. Replace sensor if necessary.</li> <li>3. Replace PIC.</li> <li>4. Replace DSC.</li> </ol>

---

<u>Status Messages:</u>	<u>Causes:</u>	<u>Corrective Actions:</u>
<b>E95 – E108 Invalid Sensor</b>	The sensor is unusable for one of the following reasons: E95 – The sensor has been connected too many times. E96-E102, E107 – The sensor contains invalid information. E103-E106, E108 – The sensor information could not be read.	<ol style="list-style-type: none"><li>1. Replace sensor.</li><li>2. Replace PIC.</li><li>3. Replace DSC.</li></ol>





## SECTION VII

### 7 SERVICING THE A-2000 SYSTEM

#### INTRODUCTION

This section provides instructions for replacing the PIC, DSC, and the Monitor, and for removing and replacing parts of the Digital Signal Converter (DSC). If a component needs to be serviced, please consult sections 7.2 and 7.3 for instructions on packaging and shipping.

The A-2000 BIS Monitoring System is designed to be easily serviced by using the built in diagnostic routines (see Section 6 of this Manual) and the major component swapping techniques described below.

#### 7.1 REPLACING MAJOR COMPONENTS

##### 7.1.1 To replace the PIC:

1. Unplug the PIC cable from the patient end of the DSC by grasping the connectors (NOT the cable!) and firmly pulling the two sections apart. The restraining loop will need to be released by clipping the nylon tie wrap to release the loop.
2. To attach the replacement PIC cable to the DSC pigtail, align and press PIC and DSC connectors together firmly. Reconnect the restraining loop by fastening to cable strain relief with the tie wrap.

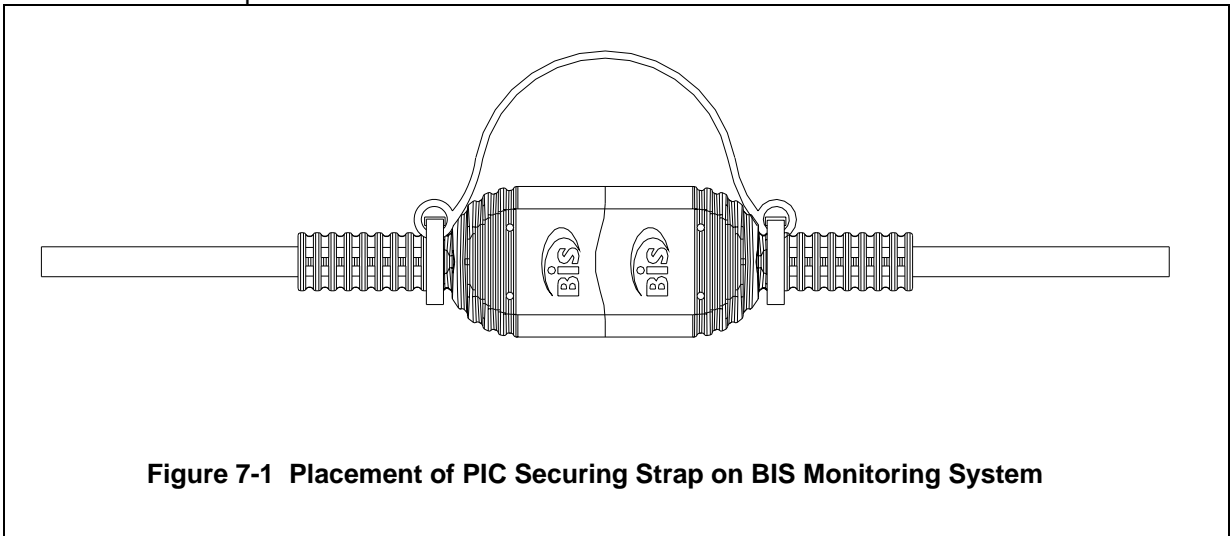

**Figure 7-1 Placement of PIC Securing Strap on BIS Monitoring System**

1. While the PIC is connected to the DSC, place the loop strap over the strain relief as indicated.
2. Insert each cable tie through the hole at the end of the loop and secure the tie firmly by pulling it through its own securing latch. Cut the excess tie so that the strap is flush to the latch and no excess material is exposed.
3. Repeat for the other side of the PIC mated cable. If cable has to be removed, do not cut the loop strap as it is intended to keep the system together. If the loop strap is cut for whatever reason, please replace as soon as possible. Order number 675-0015.

### 7.1.2 To replace the DSC:

1. Disconnect the DSC from the front of the monitor. To do this, pull on the blue rubber overlay. DO NOT twist or pull on the gray cable.
2. If necessary, unplug the PIC cable from the patient end of the DSC by grasping the connectors (NOT the wires!) and firmly pulling the two sections apart. The restraining loop will need to be released by clipping the nylon tie wrap to release the loop.
3. To install the replacement DSC, hold the cylindrical connector with the flat side up (at 12 o'clock position) and insert firmly into DSC port on front of monitor.
4. To re-attach the PIC cable, align the PIC and DSC connectors and press together firmly. Reconnect the restraining loop by fastening to cable strain relief with the tie wrap.

### 7.1.3 To replace the Monitor:

1. Power down.
2. Remove power cable from its jack in the rear.
3. Disconnect the DSC from the front of the monitor. To do this, pull on the blue rubber overlay. DO NOT twist or pull on the gray cable.
4. If required, dismount monitor from pole clamp by removing set screw from clamp, then depressing top of clamp shoe (blue plastic clip at top of aluminum pole clamp) and slide the monitor up and off of the clamp.
5. To install the replacement Monitor insert power cord to jack on rear of monitor.
6. To install DSC, hold the cylindrical connector with flat side up (at 12 o'clock position) and insert firmly into DSC port on front of monitor.
7. Re-mount pole clamp assembly.

## **7.2 FUSE REMOVAL AND INSTALLATION.**

The A-2000 contains two inline fuses (1.25A, 250V, 5x20mm Aspect P/N 430-0006) within the AC power input module located at the rear of the monitor. To check or replace a fuse, one can access these fuses as follows:

1. The fuse holder is part of the AC power input module on the rear of the monitor and is located just above the power cord input connector.
2. Disconnect the AC power cord from the wall socket and from the rear of the monitor.
3. Locate the plastic locking tabs securing the fuse holder in place.
4. Insert the tip of a ball point pen or similar tool, into the slots provided to release the plastic locking tabs allowing the fuse holder to spring out of its locked position.
5. Remove fuse holder.
6. Check fuses with an ohm meter. If replacement is needed, insert correct fuses (see below) into fuse holder.
7. To re-install the fuse holder, simply insert the fuse holder and press in with finger until the plastic locking tabs engage, securing the fuse holder in place.

### **WARNING!**

#### **REPLACE FUSES ONLY WITH ONE OF THE FOLLOWING PARTS:**

**Aspect P/N 430-0006, 1.25 Amps, 250V, 5x20mm**

**Littelfuse 217 Series, 1.25 Amps, 250V, 5x20mm**

**Wickmann 193 Series, 1.25 Amps, 250V, 5x20mm**

**ALWAYS REPLACE BOTH FUSES TOGETHER, EVEN IF ONLY ONE HAS FAILED.**

### **7.3 WHAT TO DO WITH A COMPONENT THAT REQUIRES SERVICE**

If it becomes necessary to return a major component to Aspect Medical Systems, follow the procedure below:

- Obtain return authorization: Contact Aspect's Technical Service Department to obtain a returned materials authorization (RMA) number. (The Technical Service phone number is printed on the back cover of this manual.) The RMA number should appear on the outside of the shipping container. Please provide the model number, serial number, and a brief description of the reason for return.
- Use the original shipping container, if available, or equivalent packaging to protect the product. Seal the package with plastic shipping tape rather than masking tape. Mark shipping container FRAGILE.
- If the repair or replacement is covered by the warranty, Aspect will bear the costs of shipping the repaired or replacement product back to the user. All other shipping costs shall be paid by the customer.

### **7.4 REPACKAGING FOR SHIPPING AND STORAGE**

If it becomes necessary to return the monitor to the factory, use the original shipping container to protect the product. Seal the package with reinforced packing tape rather than plastic or masking tape. Mark shipping container FRAGILE.

## 7.5 DISASSEMBLING AND REASSEMBLING THE DSC

This section provides instructions for removing and replacing parts of the Digital Signal Converter (DSC). It describes:

- Required tools and supplies
- Opening and closing the DSC case
- Removing and installing DSC cables (monitor and pigtail),
- DSC Checkout and safety tests

Note that a fully functional A-2000 BIS Monitoring System and accessories (PIC cable, Sensor Simulator or Test Sensor, and shorting bar) must be available to test any DSC that has been opened. Do not attempt these repairs unless all required equipment and tools are available!

**WARNING:**

**ANY PROCEDURES THAT REQUIRE THE REMOVAL OF THE DSC'S COVER AND INTERNAL PARTS SHOULD BE PERFORMED BY A QUALIFIED BIOMEDICAL ENGINEERING TECHNICIAN. POWER OFF THE UNIT BY DISCONNECTING FROM THE MONITOR.**

**WARNING:**

**GROUND WIRE LEAKAGE CURRENT MUST BE CHECKED BY A QUALIFIED BIOMEDICAL ENGINEERING TECHNICIAN WHENEVER THE INSTRUMENT CASE IS OPENED FOR INSPECTION OR SERVICE.**

**Caution:**

**All work involving opening the instrument case must be performed in a static-safe environment to prevent damage to electronic components and assemblies. This environment includes the operator, work area and tools, and any other test or storage items that might touch the DSC assemblies.**

### 7.5.1 Required Tools And Supplies

**Table 7.1 Tools and Supplies to Assemble/ Disassemble the DSC**

<u>Tool or Supply:</u>	<u>Part #</u>	<u>Required for:</u>
#1 Phillips screwdriver		Removing the case cover screws.
Small, flat blade screwdriver		Removing the PCB board
Needle-nose pliers		Releasing standoff tabs to separate boards
Wire cutters		Trim/remove tie wraps
A-2000 Monitor	185-0070	To perform DSC Self Test
PIC+ cable	186-0107	To perform Sensor Check (A-2000)
Sensor Simulator	186-0137	To perform Sensor Check
XP-compatible sensor	186-0106	To perform Sensor Check
DSC-XP	185-0124	To perform DSC Self Test

**Caution:**

**Use only the parts and tools specified. Use of any others may damage the instrument.**

## 7.5.2 The DSC Case

### 7.5.2.1 Opening the Case

**Caution:**

**All work involving opening the instrument case must be performed in a static-safe environment to prevent damage to electronic components and assemblies. This environment includes the operator, work area and tools, and any other test or storage items that might touch the DSC assemblies.**

**Caution:**

**Handle PCBs only by board edges to avoid contamination (moisture, skin oils, etc.) on PCB and component surfaces!**

1. Unplug the DSC from the monitor.
2. Remove the two screws from the rear of the DSC case.
3. Separate the case halves by lifting off the top (BIS Emblem) from the bottom half.
4. Remove the ground shield securing screw. See Figure 7-2.
5. Carefully remove PCB assembly; remove the shield by sliding it over the pigtail cable. See Figure 7-3.

**Caution:**

**All work involving opening the instrument case must be performed in a static-safe environment to prevent damage to electronic components and assemblies. This environment includes the operator, work area and tools, and any other test or storage items that might touch the DSC assemblies.**

**Caution:**

**Handle PCBs only by board edges to avoid contamination (moisture, skin oils, etc.) on PCB and component surfaces!**

6. Carefully separate the two printed circuit boards to gain access to cable connections. Be careful to not flex the PCBs or permanent damage to the connectors may result. See Figure 7-4.
7. Perform necessary service (e.g. replacement of cable, etc.).

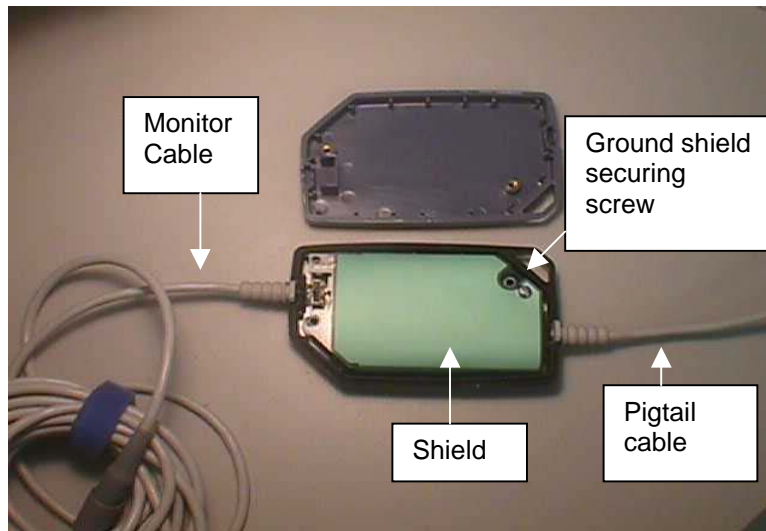
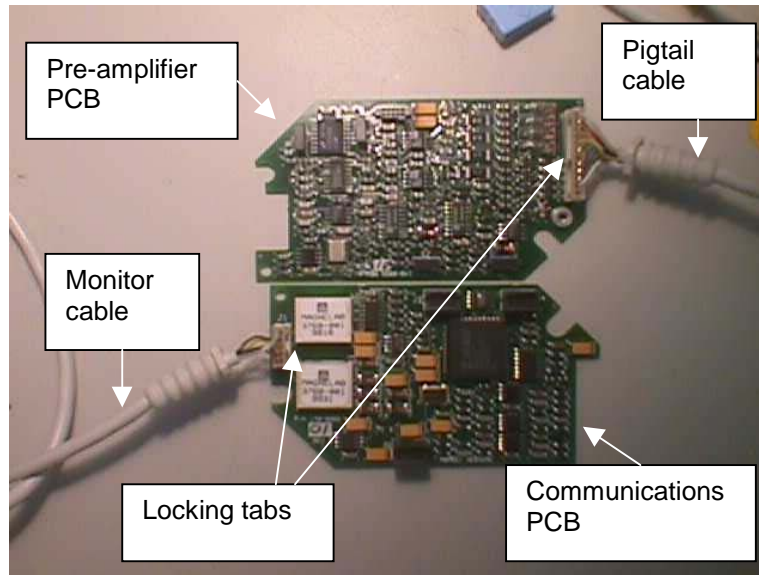

Figure 7-2 Remove the ground shield securing screw.



Figure 7-3 Remove shield by sliding along pigtail cable.



**Figure 7-4 Carefully separate the two printed circuit boards**

### 7.5.2.2 Closing the Case

**Caution:**

All work involving opening the instrument case must be performed in a static-safe environment to prevent damage to electronic components and assemblies. This environment includes the operator, work area and tools, and any other test or storage items that might touch the DSC assemblies.

**Caution:**

Handle PCBs only by board edges to avoid contamination (moisture, skin oils, etc.) on PCB and component surfaces!

1. Re-connect communications and pre-amplifier PC boards together; carefully align pins and jacks of the two printed circuit boards together, press pins firmly into jacks.
  - Verify that no pins are bent or missing their respective jacks.
2. Orient and position shield around pigtail cable, fasten shield tabs to retain shield shape.
3. Carefully slide shield into position over PCB assembly and secure with ground shield securing screw.
4. Prepare bottom case by inserting gasket into retaining groove. **NOTE:** If gasket is to be reused, note that the cable passages have an access cut in them. For a new gasket, these cable passages need to be carefully cut in one place to allow cable entry. See Figure 7-5.
5. Position and align PCB assembly with shield into bottom case assembly.
6. Align and position both cables into gasket cable passage and strain-reliefs into their cutouts. See Figure 7-6.
7. Carefully place the top case and bottom case together.
  - Verify that the sealing gasket is fully into its recess.
  - Verify that no cables are trapped at the joint.
  - Verify that both strain reliefs are fully secured in their recesses.
8. Install the two screws into the corners of the case and tighten.
9. Perform DSC Checkout and Safety tests. See section 7.5.4.

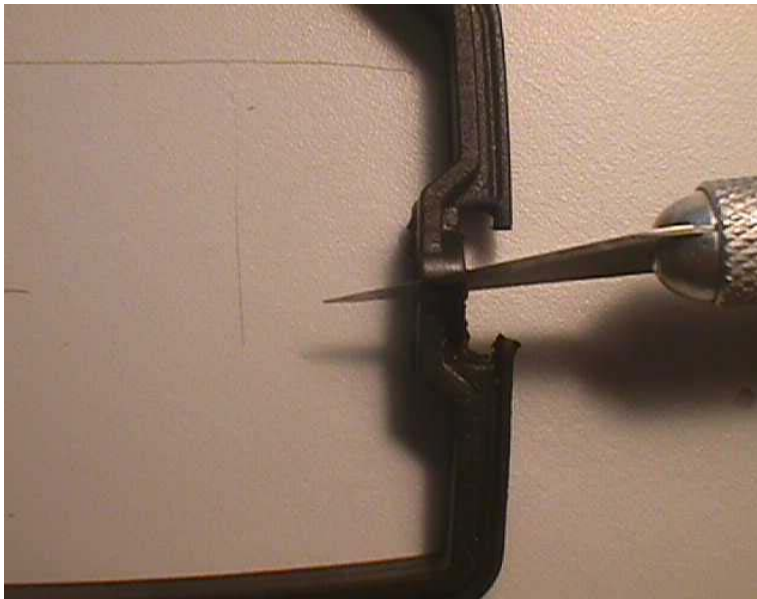

**Figure 7-5** For a new gasket, cable passages need to be carefully cut



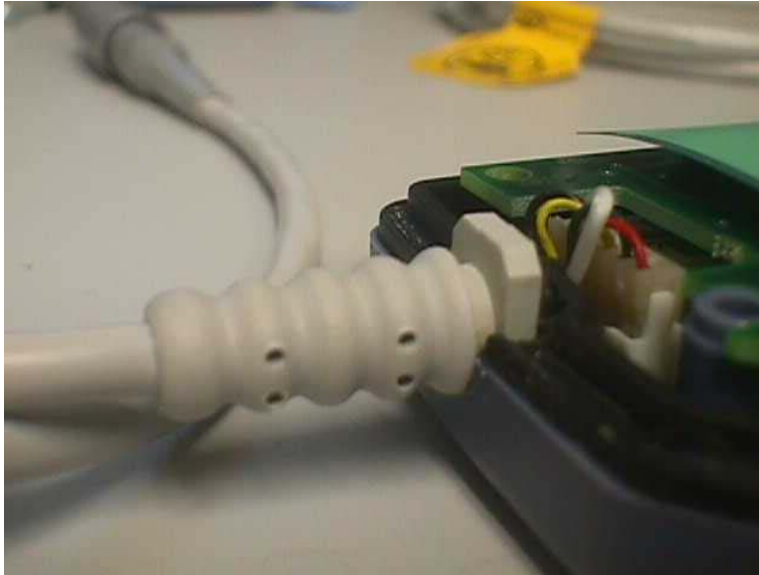

Figure 7-6 Verify that the strain relief is fully secured in its recess.

### 7.5.3 The DSC Cables (Monitor and Pigtail)

#### 7.5.3.1 Removing the Cable.

**Caution:**

**Handle PCBs only by board edges to avoid contamination (moisture, skin oils, etc.) on PCB and component surfaces!**

1. Open case according to **Opening the Case** section 7.4.2.1.
2. Remove cable by releasing the connector locking tab and pulling straight off of PCB. See Figure 7-4 to locate locking tabs.
  - Note that the Monitor cable is connected to the communications PCB.
  - Note that the Pigtail cable is connected to the pre-amplifier PCB.

#### 7.5.3.2 Installing the Cable

**Caution:**

**Handle PCBs only by board edges to avoid contamination (moisture, skin oils, etc.) on PCB and component surfaces!**

1. Install cable by aligning the cable connector to jack and carefully pressing connector into jack.  
Verify that the locking tab engages.
2. Close case according to **Closing the Case** section 7.4.2.2. above.

#### 7.5.4 DSC Checkout And Safety Tests

1. Perform DSC Self Test. See section 5.2.4. or refer to your monitor's operating manual.
  - Verify that all test sections PASS.
2. Install a known good PIC cable.
3. Connect a Sensor Simulator or Test Sensor tool as described in Appendix I
4. Perform a Patient Interface Cable (PIC) Checkout Procedure as described in section 5.2.5. of this manual. For more detail, refer to your monitor's Operating Manual.
5. Perform a leakage (electrical safety test) according to the appropriate institution requirements.
6. If appropriate perform a Hipot test according to institution requirements.

End of Procedure.

**SECTION VIII**  
**8 A-2000 SPECIFICATIONS****8.1 INTRODUCTION:**

This section lists specifications for the Aspect A-2000 BIS Monitor.

**GENERAL SPECIFICATIONS:**

- Product Description: BIS (Bispectral Index) monitor for display of processed data and real-time EEG waveforms
- Monitor Weight: 3.1 lbs (1.4 kg)
- Monitor Dimensions: 7.0 in wide x 6.8 in high x 4.0 in deep  
(17.5 cm x 16.9 cm x 10 cm)
- Digital Signal Converter:
  - Weight: 10.0 oz (0.284 kg) including integral cable
  - Dimensions: 2.60 in wide x 1.00 in high x 4.25 in deep  
(6.6 cm x 2.5 cm x 10.8 cm)
  - Cable Length: 12 ft (3.7 m) Integral DSC Cable  
4 1/2 ft (1.4 m) Patient Interface Cable
- Display Size: 3.4 in high x 4.5 in wide (8.5 cm x 11.25 cm)
- Digital Output: RS232 serial port, printer port, isolated from ground
- Power Requirements: 100-240 VAC, 50-60 Hz, 1 ampere max.
- Electrical Safety: Conforms to: UL 2601, CSA 22.2 No. 601-1 and IEC 601-1
- Battery Backup: 20 minutes at full operation  
Recharge Time: 4 hours
- Software Updates: User-via RS-232 serial port
- Processors: Texas Instruments TMS 320C32 (50 MHz), Sharp LH77790 Risc (25 MHz)

**EEG SPECIFICATIONS:**

- Epoch Duration: 2 seconds
- Artifact Rejection: Automatic
- EEG Scales: 25  $\mu\text{V}/\text{div}$  (+/- 1 mV Full Scale)  
Display Type – EEG: 5, 10, 25, 50 or 100  $\mu\text{V}/\text{div}$
- EEG Sweep Speeds: 25 mm/sec  
Display Type – EEG: 15, 25, or 30 mm/sec
- Computed Parameters: Bispectral Index, 95% Spectral Edge Frequency, Suppression Ratio, EMG, and Signal Quality Index
- User-defined Displays: TREND, DSA, BIS Log and real-time EEG waveforms
- Update Rate: 1 second for BIS Index, 10 seconds for Trend/DSA
- Event Markers: User selected
- Alarms: Auditory and visual, user adjustable limits
- Filters: ON (2 - 70 Hz with notch) or OFF (.25 - 100 Hz)
- Mode: Sensor automatically selects mode.

**DIGITAL SIGNAL CONVERTER SPECIFICATIONS:**

- Analog to Digital Converter: Noise-shaped sigma-delta
- Sampling Rate: 16,384 samples/second
- Resolution: 16 Bits at 256 samples/second
- Input Impedance: 50 Mohms minimum
- Noise: < 0.3  $\mu\text{V}$  RMS (2.0  $\mu\text{V}$  peak-to-peak);  
0.25 Hz to 50 Hz
- Common Mode Rejection: 110 dB at 50/60 Hz to earth  
(Isolation mode) ground
- Bandwidth: **DSC– 2:** 0.16 - 800 Hz  
**DSC– XP:** 0.16 – 450 Hz

**OPTIONS AND ACCESSORIES:**

BIS sensor  
Patient Interface Cable - Plus (PIC Plus)  
Pole Clamp for Monitor  
Monitor Stand  
Printer

**TYPE OF PROTECTION AGAINST ELECTRIC SHOCK OF THE SYSTEM:**

Class 1: Equipment in which protection against electric shock does not rely on basic insulation only, but which includes an additional safety precaution. Means are provided for the connection of the equipment to the protective earth conductor in the fixed wiring of the installation in such a way that accessible metal parts cannot become live in the event of a failure of the basic insulation.

**DEGREE OF PROTECTION AGAINST ELECTRIC SHOCK OF THE SYSTEM:**

Type BF: Equipment providing a degree of protection against electric shock regarding allowable leakage currents and reliability of the protective earth ground connection with an F-type applied part. An F-type applied part is isolated from all other parts of the equipment to such a degree that the patient leakage current allowable in single fault condition is not exceeded when a voltage equal to 1.1 times the highest rated AC supply voltage is applied between the applied part and earth.

**DEGREE OF PROTECTION AGAINST EFFECTS OF CARDIAC DEFIBRILLATION:**

The A-2000 system provides protection for the operator and patient during cardiac defibrillation.

**DEGREE OF PROTECTION AGAINST THE INGRESS OF WATER:**

Monitor degree of protection rating: IPX2 (ingress of water dripping)  
DSC degree of protection rating: IPX4 (splash proof)

**MODE OF OPERATION OF THE SYSTEM:**

Continuous: Operation under normal load for a normal period without exceeding the specified limits of temperature.

**CLASSIFICATION:**

**MEDICAL ELECTRONIC EQUIPMENT**  
CLASSIFIED BY UNDERWRITERS LABORATORIES INC.®  
WITH RESPECT TO ELECTRIC SHOCK, FIRE AND MECHANICAL HAZARDS ONLY  
IN ACCORDANCE WITH  
UL 2601-1, IEC601-2-26  
CAN/CSA C22.2 NO. 601.1, CAN/CSA 601.2.26  
42SA

## 8.2 WARRANTY

Aspect warrants to the initial Purchaser that the A-2000 BIS monitor and the Digital Signal Converter ("Warranted Product") will be free from defects in workmanship or materials, when given normal, proper, and intended usage for a period of one year ("Warranty Period") from the date of its initial shipment to Purchaser. Excluded from this warranty are expendable components and supply items such as, but not limited to, electrodes, cables, and prep solutions. Aspect's obligations under this warranty are to repair or replace any Warranted Product (or part thereof) that Aspect reasonably determines to be covered by this warranty and to be defective in workmanship or materials provided that the Purchaser has given notice of such warranty claim within the Warranty Period and the Warranted Product is returned to the factory with freight prepaid. Repair or replacement of Products under this warranty does not extend the Warranty Period.

To request repair or replacement under this warranty, Purchaser should contact Aspect directly (see contact information on the back cover of this manual). Aspect will authorize Purchaser to return the Warranted Product (or part thereof) to Aspect. Aspect shall determine whether to repair or replace Products and parts covered by this warranty and all Products or parts replaced shall become Aspect's property. In the course of warranty service, Aspect may but shall not be required to make engineering improvements to the Warranted Product or part thereof. If Aspect reasonably determines that a repair or replacement is covered by the warranty, Aspect shall bear the costs of shipping the repaired or replacement Product to Purchaser. All other shipping costs shall be paid by Purchaser. Risk of loss or damage during shipments under this warranty shall be borne by the party shipping the Product. Products shipped by Purchaser under this warranty shall be packaged in the original shipping container or equivalent packaging to protect the Product. If Purchaser ships a Product to Aspect in unsuitable packaging, any physical damage present in the Product on receipt by Aspect (and not previously reported) will be presumed to have occurred in transit and will be the responsibility of Purchaser.

This warranty does not extend to any Warranted Products or part thereof: that have been subject to misuse, neglect, or accident; that have been damaged by causes external to the Warranted Product, including but not limited to failure of or faulty electrical power; that have been used in violation of Aspect's instructions; that have been affixed to any nonstandard accessory attachment; on which the serial number has been removed or made illegible; that have been modified by anyone other than Aspect; or that have been disassembled, serviced, or reassembled by anyone other than Aspect, unless authorized by Aspect. Aspect shall have no obligation to make repairs, replacements, or corrections which result, in whole or in part, from normal wear and tear. Aspect makes no warranty (a) with respect to any products that are not Warranted Products, (b) with respect to any products purchased from a person other than Aspect or an Aspect-authorized distributor or (c) with respect to any product sold under a brand name other than Aspect Medical Systems, Inc.

THIS WARRANTY IS THE SOLE AND EXCLUSIVE WARRANTY FOR ASPECT'S PRODUCTS, EXTENDS ONLY TO THE PURCHASER, AND IS EXPRESSLY IN LIEU OF ANY OTHER EXPRESS OR IMPLIED WARRANTIES INCLUDING WITHOUT LIMITATION ANY WARRANTY AS TO MERCHANTABILITY OR FITNESS FOR A PARTICULAR PURPOSE. ASPECT'S MAXIMUM LIABILITY ARISING OUT OF THE SALE OF THE PRODUCTS OR THEIR USE, WHETHER BASED ON WARRANTY, CONTRACT, TORT, OR OTHERWISE, SHALL NOT EXCEED THE ACTUAL PAYMENTS RECEIVED BY ASPECT IN CONNECTION THEREWITH. ASPECT SHALL NOT BE LIABLE FOR ANY INCIDENTAL, SPECIAL, OR CONSEQUENTIAL LOSS, DAMAGE OR EXPENSE (INCLUDING WITHOUT LIMITATION LOST PROFITS) DIRECTLY OR INDIRECTLY ARISING FROM THE SALE, INABILITY TO SELL, USE OR LOSS OF USE OF ANY PRODUCT. EXCEPT AS SET FORTH HEREIN, ALL PRODUCTS ARE SUPPLIED "AS IS" WITHOUT WARRANTY OF ANY KIND, EITHER EXPRESS OR IMPLIED.





## SECTION IX

### 9 APPENDIX I

#### 9.1 SPARES AND ACCESSORIES LIST

<b>MAJOR COMPONENTS:</b>	
185-0070	A-2000 Monitor
185-0071	DSC-2 Assembly (serial number D3nnnnn)
186-0159-RFB	DSC-XP (serial number DXnnnnn)
186-0067	PIC-S Cable
186-0107	PIC+, for DSC (serial number DXnnnnn, D4nnnnn)
186-0100	BIS Standard sensor
186-0106	BIS Quatro sensor
186-0110	BIS Pediatric sensor
186-0200	BIS Pediatric (XP) sensor
186-0160	BIS Extend sensor
175-0039	Power Cord 10' North America
175-0038	Power Cord 15' North America
150-0058	BIS Monitor Stand
<b>ACCESSORIES:</b>	
186-0031	A-2000 Printer
186-0109	Paper, Printer
150-0037	Pole Clamp Assembly
<b>PARTS:</b>	
675-0015	Restraining loop
430-0006	Fuse 1.25a 250V 5X20MM
175-0021-PI	Monitor Cable (12' length, monitor to DSC box)
175-0022	Pigtail Cable for DSC s/n D2..., D3..., (3' length, DSC to PIC connector)
175-0045-PI	Pigtail cable, for DSC S/N DX..., D4... (9" length, DSC to PIC connector)
150-0027	Shield
150-0026	Gasket
675-0004	Tie wrap
605-0024	Screw, case
605-0022	Screw, shield
800-0007	Hanging strap clip
675-0022	Cable wrap (Blue, Velcro)
<b>MISCELLANEOUS</b>	
180-0006	Empty carton, with foam, A2000
186-0105	Sensor Simulator for DSC serial numbers D2nnnn, D3nnnn
186-0137	Sensor Simulator for DSC serial numbers DXnnnnn, D4nnnnn and PIC Adaptor.

Operating Manuals for BIS Monitoring Systems are available at:  
[www.aspectmedical.com/asrs](http://www.aspectmedical.com/asrs)

## 9.2 SENSOR SIMULATOR: P/N: 186-0137 FOR USE WITH DSC-XP:

### **BIS Sensor Simulator Instructions for use:**

Insert 2CH/4CH BIS Sensor Simulator service tool into patient interface cable. Impedance test will be initiated by BIS Monitoring System when it detects that simulator has been inserted.

Note: This product is NOT intended for use with the DSC-2

**Description of tool:** The 2CH/4CH BIS Sensor Simulator is a service tool that allows for the verification of proper impedance values being detected by the BIS Monitoring System during the "Sensor check". This test is part of the initial test that each monitor performs. The simulator also allows for safety testing of BIS monitors in the field by allowing connection of the test equipment to the monitor via the patient interface cable (PIC).

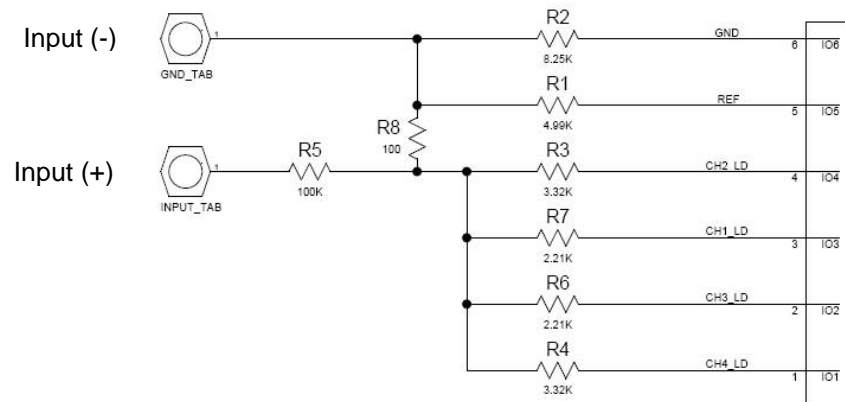

Figure 1: Schematic of the 2CH/4CH BIS Sensor Simulator circuitry. IO3 – IO6 connect to 4 input signal pins on a 2 channel patient interface cable. IO1 – IO6 connect to 6 input signal pins on a 4 channel patient interface cable. The Inputs (+ and -) are where one connects the test signals to test the BIS Monitor.

### **Test types allowed:**

#### **Sensor check**

This checks and verifies that the monitor is reporting the proper impedances that it sees from the BIS Sensor Simulator. This procedure verifies the proper functionality of the BIS monitoring system. Connect the BIS Sensor Simulator to the BIS Monitor at the patient interface cable. The monitor should proceed to recognize that a sensor was connected and report the proper impedance values as shown below in table 1:

Electrode #	1	2	4	3
Acceptance Range in Kohms	4-6	8-17	3-5	2-4

**Table 1: BIS Sensor Simulator individual electrode impedance range**

The monitor then proceeds to display the BIS screen. The BIS value is blanked and after a few seconds, SQI=100.

**Safety Testing: Leakage Current**

***Leakage current testing should be performed by a qualified Engineering Technician or authorized personnel only.***

- Connect the BIS Sensor Simulator to the patient interface cable of the BIS monitor as if it was a sensor connection.
- Short the two circular terminals at the end of the simulator using conventional methods such as jumpers or alligator clips.
- Connect the test signal to the shorted terminals. Make sure that you are not touching the BIS Sensor Simulator beyond this point.

Proceed to test instrument for Leakage current as per established facility protocols and procedure for safety testing of medical devices.



**Safety Tester**

**Simulator Cleaning**

- Wipe simulator surfaces with a wet cloth soaked in lukewarm tap water containing bleach solution of 10% by volume.
- Wipe simulator surfaces with a wet cloth of lukewarm tap water
- Dry with a clean cloth and allow to dry.

**9.3 TEST SENSOR**

Use the following procedure to make a Test Sensor:

1. Remove a new sensor from its plastic carrier sheet and place on flat surface with the adhesive facing up.

**NOTE:**

Be careful that gel does not leak onto hands or connector during this procedure.

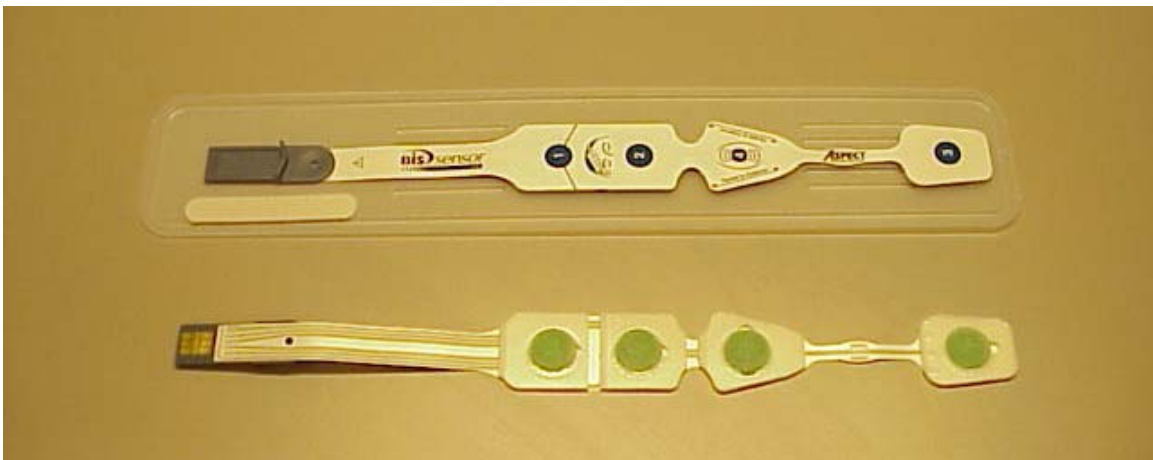

**Figure 9-1 BIS Sensor**

2. Place the end of a small paper clip at the midpoint of electrode #2 then lay it across electrode #4. (See Figures 9-3 and 9-4.)

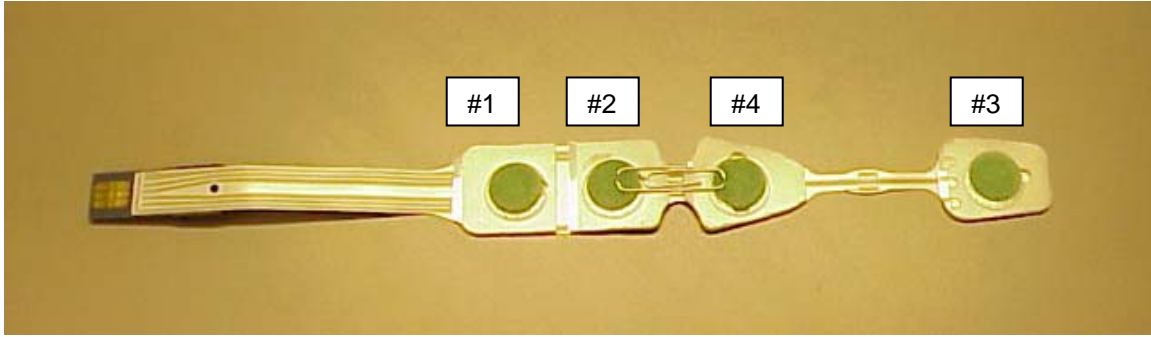

**Figure 9-2 Connecting electrodes #2 and #4.**

3. Fold electrode #3 over onto electrode #4, pressing adhesive surfaces together and making sure the paper clip remains in place.
4. Fold electrode #1 over onto electrode #2.



**Figure 9-3 Connecting electrode #3 with #4, and #1 with #2.**

5. Connect this Test Sensor to the PIC. All impedance tests should complete successfully, with low impedance values. Typical values using this alternative Test Sensor are less than 5 K ohms.
6. The following chart shows expected Test Sensor values:

Test Sensor Values		
Electrode #	Typical	Range
1	1 K ohm	1-2 K ohms
2	1 K ohm	1-3 K ohms
4	1 K ohm	1-2 K ohms
3	1 K ohm	1-2 K ohms

#### 9.4 SAFETY TESTER CONNECTION WITH PIC

This procedure describes a method to connect an A-2000 BIS Monitor System to a safety tester. It uses a current date sensor to provide a contact point for the safety tester leads that correspond to the patient contact points of the BIS System.

1. Connect DSC (Digital Signal Converter) cable to A-2000 monitor.
2. Connect PIC (Patient Interface Cable - sensor) cable to other end of DSC.
3. Verify sensor for test is of current date code. Connect sensor to PIC cable.
4. Remove gel and green pad from each sensor contact point.
5. Connect safety tester leads per tester instructions to sensor contact point metallized pads (i.e. via alligator clips).
6. Apply power to the A-2000 per safety tester instructions. Make required leakage measurements.
7. Disconnect and dispose of sensor. NOTE: DO NOT discard PIC or DSC. These are re-usable components.

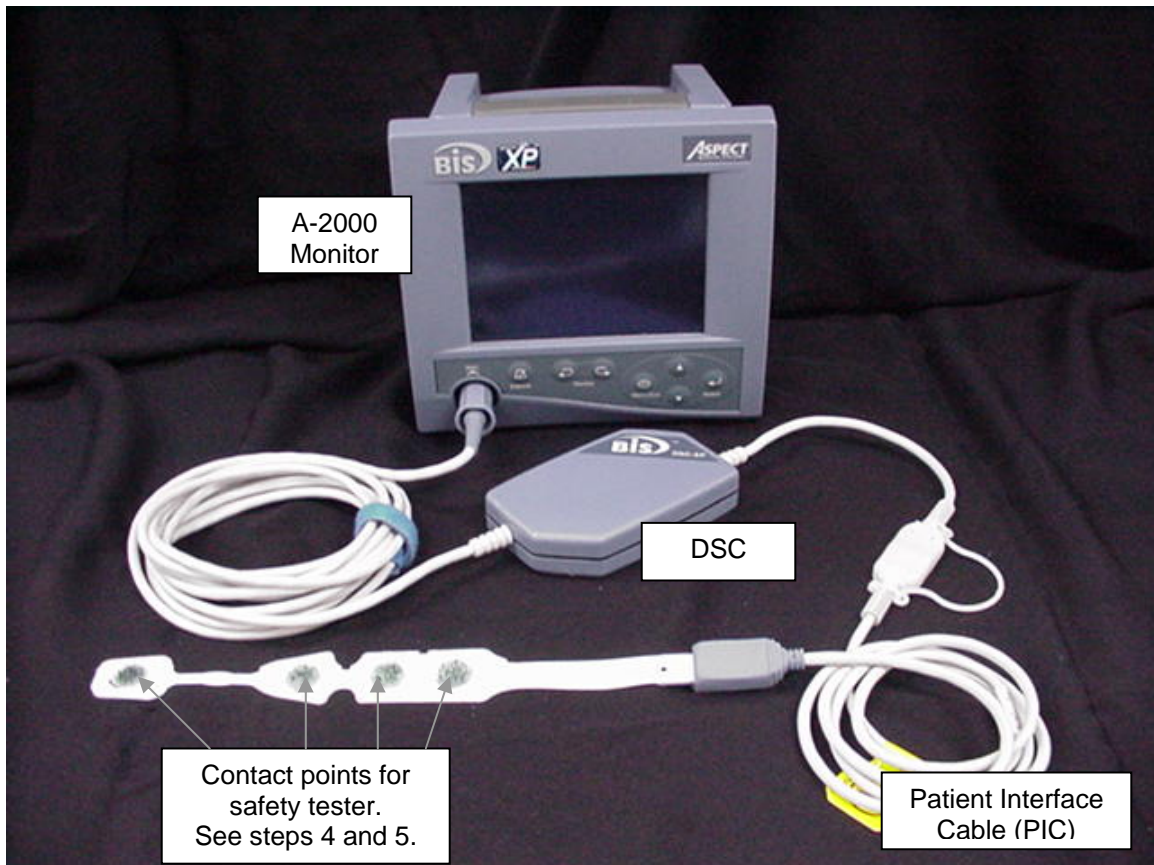
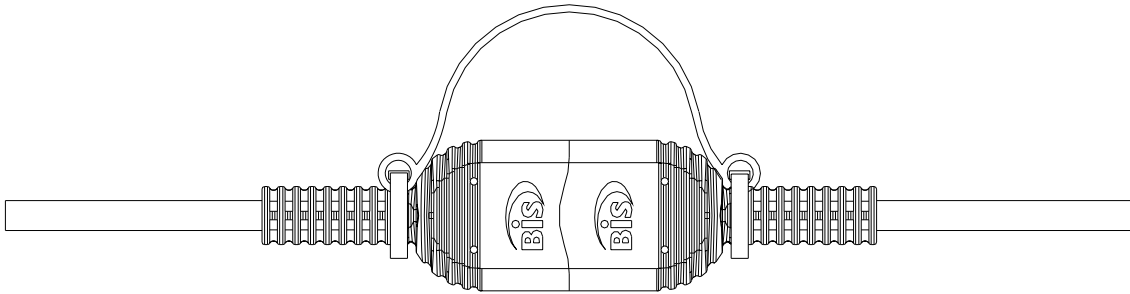

Figure 9-4 Safety Tester Contact Points

### 9.5 PLACEMENT OF PIC SECURING STRAP ON BIS MONITORING SYSTEM



1. While the PIC is connected to the DSC, place the loop strap over the strain relief as indicated.
2. Insert each cable tie through the hole at the end of the loop and secure the tie firmly by pulling it through its own securing latch. Cut the excess tie so that the strap is flush to the latch and no excess material is exposed.
3. Repeat for the other side of the PIC mated cable.

If cable has to be removed, do not cut the cable tie as it is intended to keep the system together. If the loop strap is cut for whatever reason, please replace as soon as possible.

The PIC part number, 186-0107 (PIC with Loop Strap, Tiewraps and Label) includes the following:

- 1 each 675-0015 – Tie (Loop strap)
- 2 each 675-0004 – Tie Wrap
- 1 each 194-0039 – Label, do not discard
- 1 each 071-0002 – Document, instructions

**SECTION X**  
**10 APPENDIX II**

**10.1 A-2000 SIGNAL FLOW DIAGRAM**

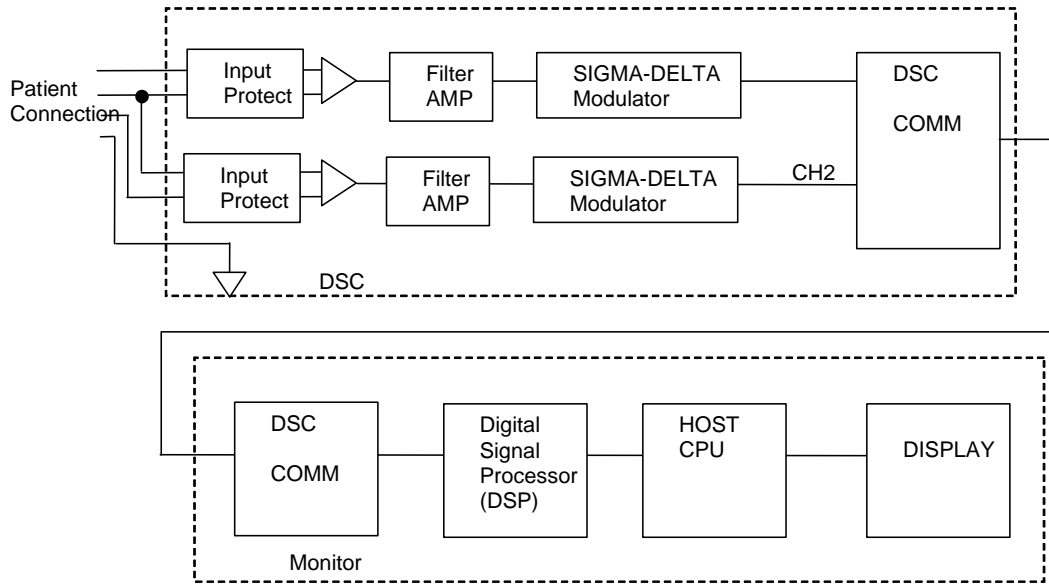

10.2 A-2000 BLOCK DIAGRAM

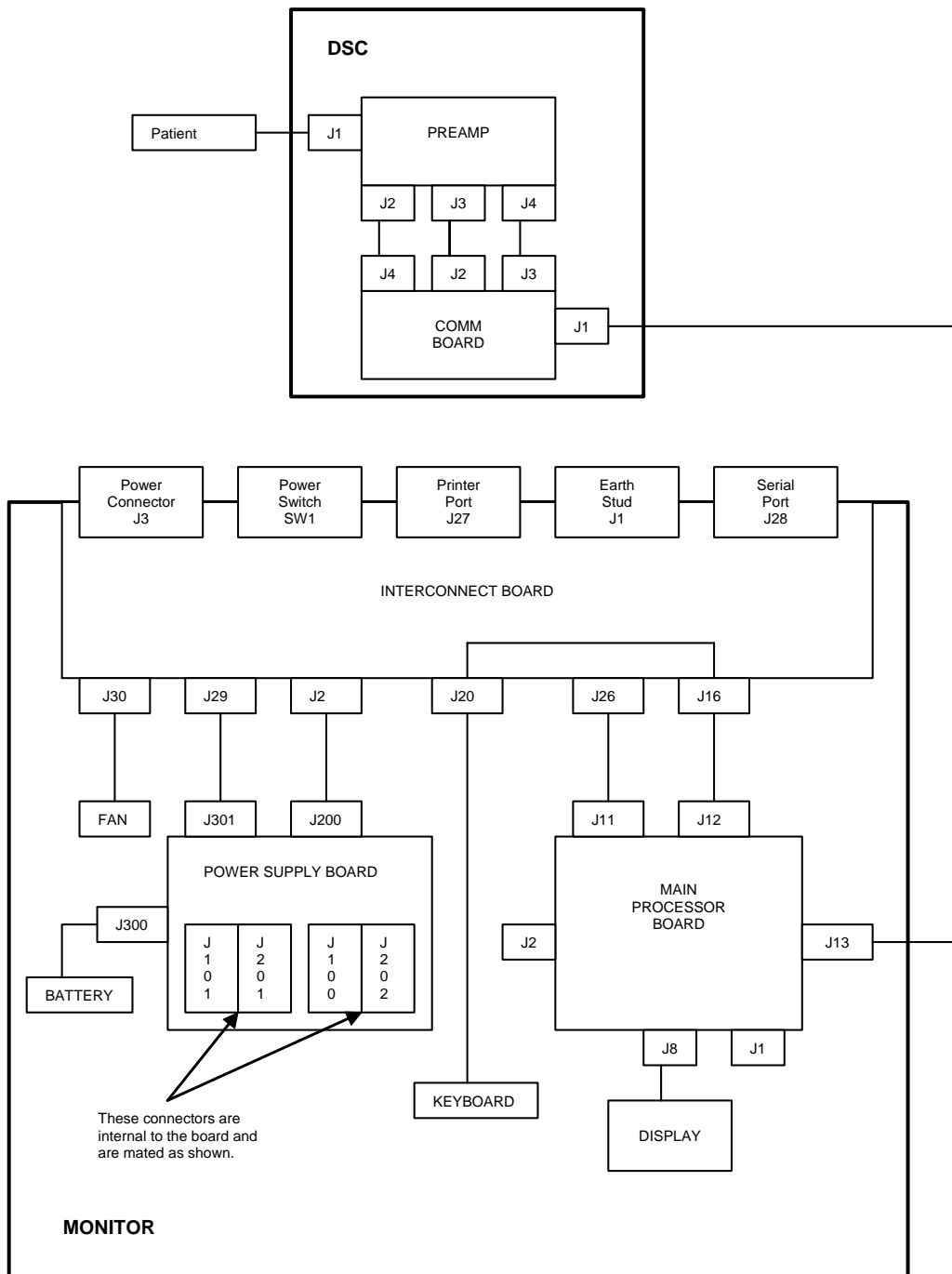

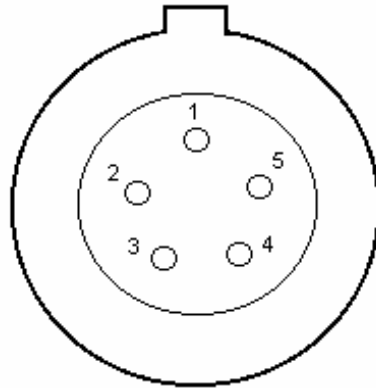

**10.3 DSC WIRING DIAGRAM; DSC CONNECTOR (wire side)**

Pin#	Wire Color	Signal Name
Pin 1	RED	HBCTLH
Pin 2	GREEN	HBCTLL
Pin 3	YELLOW	HBIN+
Pin 4	BLACK	GND
Pin 5	TEFLON	CHAS GND

### 10.4 WIRING DIAGRAM; MONITOR CABLE

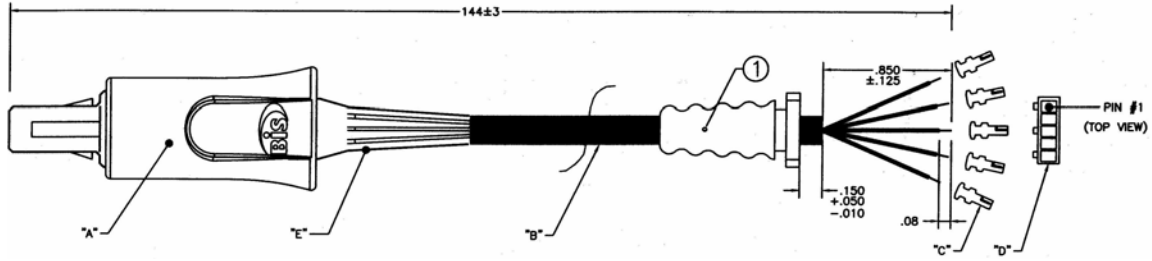

LEMO Pin #	Wire Color	Stocko Pin #
1	Red	1
2	Green	2
3	Yellow	3
4	Black	4
5	Drain/Teflon	5

**10.5 WIRING DIAGRAM; PIGTAIL CABLE**

Stocko Connector	Wire Color	Pigtail Connector
1	Drain/Teflon	10
2	Brown	1
3	Red	3
4	Orange	2
5	Yellow	5
6	Green	4
7	N/C	N/C
8	Blue	6
9	Purple	7
10	Gray	8
11	White	9
12	N/C	N/C

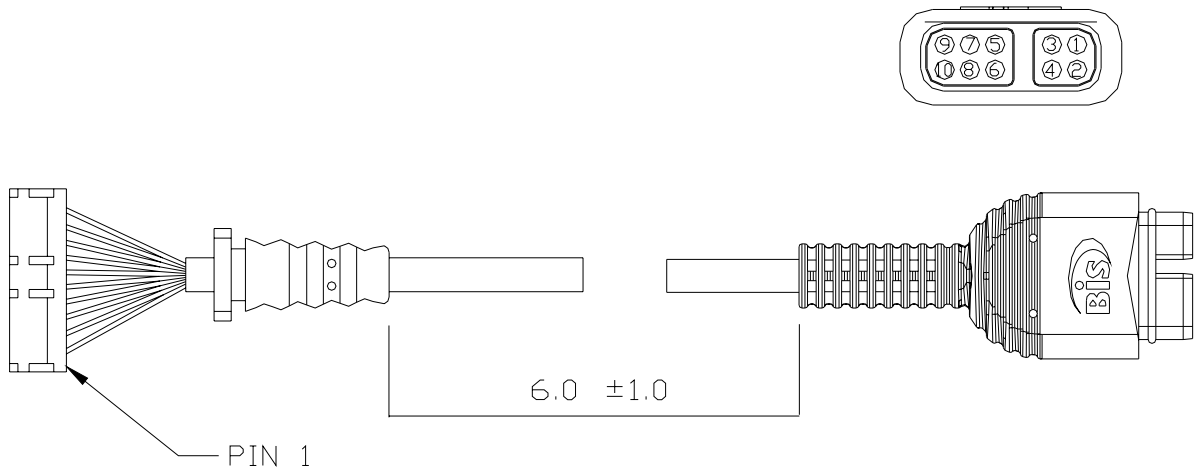





Contact Information for:



**Aspect Medical Systems, Inc.**

One Upland Road  
Norwood, MA 02062  
U.S.A.

Main Business Phone: (617) 559-7000  
Main Business Fax: (617) 559-7400  
Customer Service: (888) BIS-INDE(X)...press (6)  
OR (800) 442-7688 ... press (6)  
Technical Service: (800) 442-2051

Email: [bis\\_info@aspectms.com](mailto:bis_info@aspectms.com)  
Web: [www.aspectmedical.com](http://www.aspectmedical.com)



**Aspect Medical Systems International B.V.**

Rijnzathe 7d2  
3454 PV De Meern  
The Netherlands

Main Business Phone: +31.30.662.9140  
Main Business Fax: +31.30.662.9150  
Email: [amsint@aspectms.com](mailto:amsint@aspectms.com)



Recyclable